

Temperature controller for hot runners

1/16 DIN - 48 x 48 mm

gammadue® series M2 line

Born for the hot runners

This controller has been designed to meet the special requirements of the plastic industry and more specifically of the hot runners applications. Selective set point modification from digital input within a bank of controllers, freezing of the controller output to the most suitable value in case of emergency conditions, momentary target set point visualisation during machine start-up and front keys lock are the typical functions required by hot runners machines.

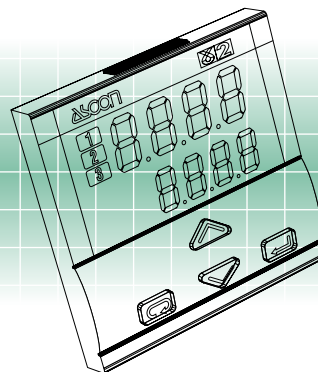
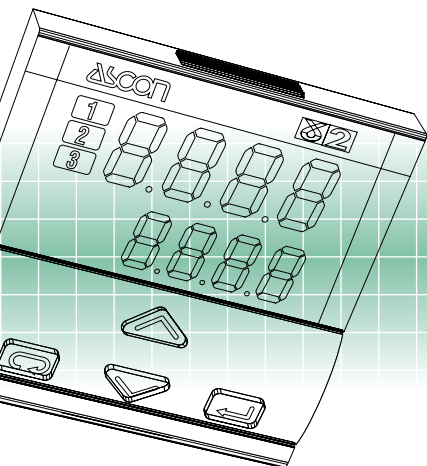
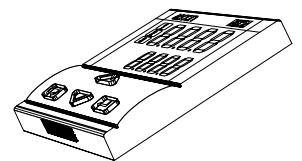
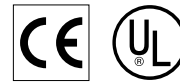

E

ISO 9001 Certified

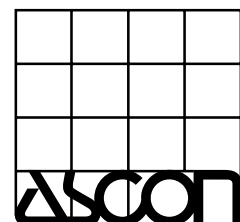

ASCON spa

20021 Bollate - (Milano) Italy - Via Falzarego, 9/11 - Tel. +39 02 333 371 - Fax +39 02 350 4243
<http://www.ascon.it> e-mail info@ascon.it

gammadue®

the right solution to your needs



Your needs	Our solutions
Simultaneous set point modification on several controllers	Set point modification from digital input with optional accessory
Control availability during emergency	Average safety output
Easy replacement and quick start-up	Configuration by simple to use codes
Process with time variable characteristic	Two initial and one continuous calculations of the right control parameters
Alarm signalling	Absolute, band and deviation alarms, Latching/Blocking
Interfacing with other devices	Serial communications at 9600 baud Modbus/Jbus protocol, analogue retransmission output
Quick learning	Every model has the same operating method
Ergonomic compatibility with other devices	Two colours: beige or darkgrey front panels
Environmental protection	IP65 front panel protection (indoor, dust and water protection)
Easy to use	Ergonomic keypad, clear and comprehensive display
Noise immunity	Electromagnetic compatibility
Universal input signals, linear as well as non-linear	Configurable input (TC, RTD, mA, Volt and ΔT , infrared sensor, "custom" linearisation)
Cost reduction	Built-in Timer and Start-up functions
Reliability and safety	CE compatibility, ASCON is ISO 9001 certified, 3 years warranty
Technical support	Technical application assistance from ASCON sales and after sales service

Resources

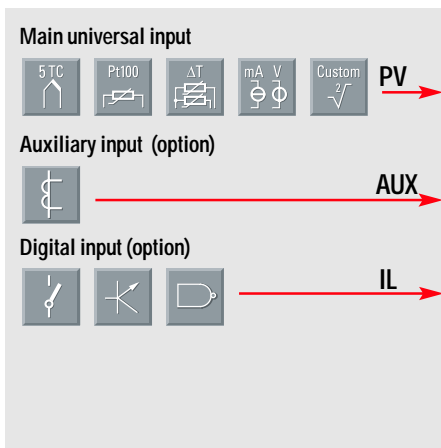

Operating mode

	Control	Alarms
1 Single action	OP1	OP2 OP3
2 Single action	OP2	OP1 OP3
3 Double action	OP1 OP3	OP2
4 Double action	OP1 OP2	OP3
5 Double action	OP2 OP3	OP1

Setpoint



Special functions



Fuzzy tuning with automatic selection



Continuous tuning



Digital input (IL) functions



Technical data

Features at env. 25°C	Description			
Total configurability	From keypad the user selects: type of input - operating mode - type of control algorithm - type of output and safe conditions - alarm types and functionality			
PV input (for signal ranges see table 1)	Common characteristics	A/D converter with 50.000 points Update measurement time : 0.2 sec Sampling time : 0.5 sec Input shift : -60... + 60 digits Input filter : 1...30 sec (OFF= 0)		
	Accuracy	0.25% ± 1 digit (T/C and RTD) 0.1% ± 1 digit (mA and mV)	Between 100 and 240V ~ error is minimal	
	Resistance thermometer (for ΔT: R1+R2 must be <320Ω)	Pt100Ω at 0°C (IEC 751) °C / °F selectable	2 or 3 wire connection	Line: 20Ω max (3 wire) Thermal drift 0.1°C/10°C env. T. <0.1°C/10Ω line resist.
	Thermocouple	L, J, T, K, S (IEC 584) °C / °F selectable	Internal cold junction compensation	Line: 150Ω max Thermal drift <2μV/°C env. T. <0.5μV/10Ω line resist.
	DC input (current)	0/4...20mA with 2.5Ω ext. Shunt Rj > 10MΩ	Engineering units, floating decimal point, Low Range -999...9999	Input drift: <0.1% / 20°C env. T.
	DC input (voltage)	0/10...50mV, Rj > 10MΩ	High Range -999...9999 100 digits minimum	
Auxiliary input	CT current transformer	50 or 100mA input hardware selectable	Current visualization 10...200 A with 1A resolution and Heater break alarm	
Digital input (option)	The closure of the external contact produces any of the following actions:		Auto/Man mode change, Stand-by Setpoint activation, keypad lock	
Operating modes	1 double action PID loop or ON/OFF with 1 or 2 alarms			
Control mode	Algorithm	P.I.D. with overshoot control or ON/OFF		
	Proport. band (P)	0.5...999.9%		
	Integral time (I)	0.1...100.0 min	OFF = 0	P.I.D. algorithm
	Derivative time (D)	0.01...10.00 min		
	Error band	0.1...0.10 digit		
	Cycle time	1...200 sec.		
	Dead band	-10.0...10.0		
	Relative cool gain	0.1...10.0		For Heat/Cool mode
	Cool cycle time	1...200 sec.		
	Overshoot control	0.01...1.00		
High limit	100.0...10.0% (heat) -100.0...-10.0% (cool)		P.I.D. algorithm	
Hysteresis	0.1...10.0%		ON/OFF algorithm	
OP1 output	SPST relay N.O., 2A/250V~ for resistive load			
OP2 output	Logic not isolated: 5V-, ± 10%, 30 mA max SPST relay (option) N.O., 2A/250V~ for resistive load			
OP3 output	SPST Relay N.O., 2A/250V~ for resistive load			
AL2-AL3 alarms	Hysteresis 0.1 ... 10.0% of range			
	Action	Active high	Action type	Deviation threshold ± range
		Active low		Band threshold 0...range
		Special function	Sensor break, Heater break, Loop break Latching/Blocking	
Setpoint	Local and stand-by, digital input			
	Up and down ramps		0.1...999.9 digit/min (OFF = 0)	
	Low limit	from low range to high limit		
Tuning	High limit	from low limit to high range		
	Fuzzy-Tuning the controller selects automatically the best method according to the process conditions		Step response	
	Adaptive-Tuning self-learning, not intrusive, analysis of the process response to perturbations and continuously calculation of the PID parameters		Natural frequency	
Aut/Man Station	Standard with bumpless function, by keypad and digital input			

Input type	Scale range
RTD	-99.9...300.0 °C
	-99.9...572.0 °F
Pt100Ω a 0°C	-200...600 °C
	-328...1112 °F
T/C type L	0...600 °C
Fe-Const.	32...1112 °F
T/C type J	0...600 °C
Fe-Cu 45% Ni	32...1112 °F
T/C type T	-200...400 °C
Cu - CuNi	-328...752 °F
T/C type K	0...1200 °C
Cromel Alumel	32...2192 °F
T/C type S	0...1600 °C
Pt10%Rh-Pt	32...2912 °F
0/4...20 mA	Configurable engineering units
0/10...50 mV	mA, mV, V, bar, psi, Rh, ph
mV Custom scale	On request

Table 1: PV input

Special functions

- Set point modification from digital input

With only one digital input on the controller and by means of the APG2-DRSPC accessory (on request) it is possible:

- to increase by step the set point
- to decrease by step the set point
- to switch the set point from local to stand-by and viceversa.

The value of the step is a parameter equal for both set point increase and decrease. Setpoint modification function can be easily turned off from the keypad.

The outputs of the APG2-DRSPC accessory are isolated and can be used to drive up to 48 controllers.

- Average safety output (option)

In case of sensor break the controller output is automatically locked at a value equal to the average of the outputs of the last 50 seconds of operation.

Technical data

Features at env. 25°C	Description	
Operational safety	Measure input	Detection of out of range, short circuit or sensor break with automatic activation of the safety strategies and alerts on display
	Control output	Safety value: 0... 100% (-100... 100% for heat/cool) or average safety output (option)
	Parameters	A non-volatile memory stores for unlimited time all the parameter and configuration values
	Password	Password to access the configuration and parameters data
General characteristics	Power supply	100-240V~ (-15% +10%) 50/60Hz or 24V~(-25% +12%), 50/60Hz and 24V- (-15% +25%). Power consumption 3 VA max
	Safety	Compliance EN61010-1 (IEC 1010-1), installation class 2 (2500V), pollution class 2, class II instrument
	Electromagnetic compatibility	Compliance to the CE standards for industrial system and equipment
	Protection EN60529 (IEC 529)	IP65 front panel
	Overall dimensions	$\frac{1}{16}$ DIN - 48 x 48, depth 120 mm, weight 130g appr. Panel cut-out: $45^{+0.6} \times 45^{+0.6}$ mm

Electrical wirings

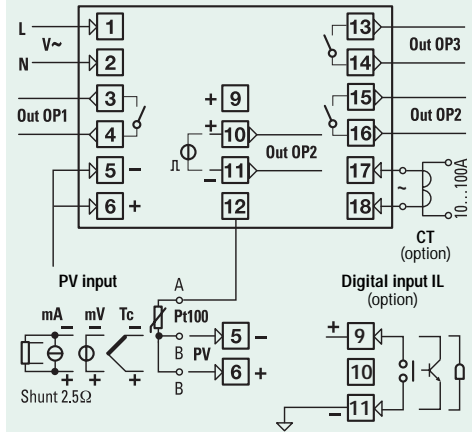

Ordering codes

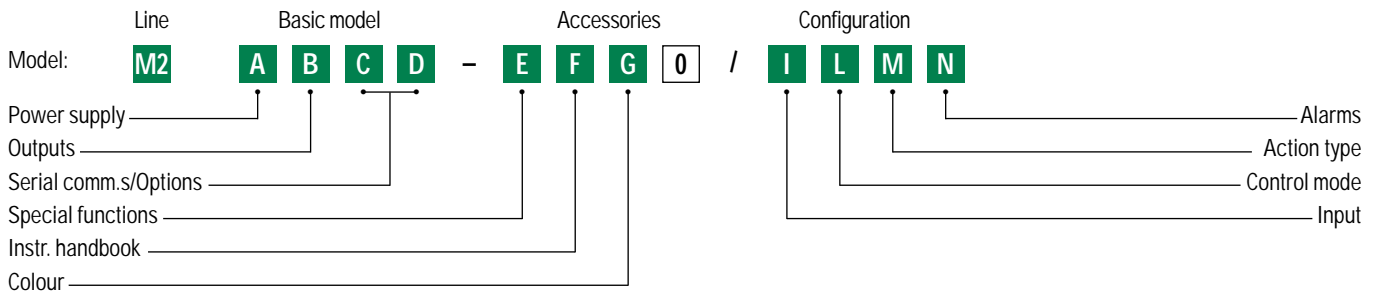

Power supply	A
100-240V~ (-15% +10%)	3
24V~ (-25% +12%) or 24V- (-15% +25%)	5

OP2 Outputs	B
Relay and Logic	1
Only Logic	6

Digital input	Options	C	D
Not fitted	None	0	0
	Current transformer input (CT) [1]	0	3
Fitted	None	9	0
	CT [1]	9	3

Special functions	E
Not fitted	0
Setpoint modification from digital input	6
Safety average OP on sensor break	7
Setpoint modification from digital input + average safety output	8

User manual	F
Italian-English (std)	0
French-English	1
German-English	2
Spanish-English	3

Front case colour	G
Dark (std)	0
Beige	1

[1] Only for B=1

Input type	Range scale	I
RTD Pt100 IEC751	-99.9...300.0 °C -99.9...572.0 °F	0
RTD Pt100 IEC751	-200...600 °C -328...1112 °F	1
TC L Fe-Const DIN43710	0...600 °C 32...1112 °F	2
TC J Fe-Cu45% Ni IEC584	0...600 °C 32...1112 °F	3
TC T Cu-CuNi	-200...400 °C -328...752 °F	4
TC K Chromel -Alumel IEC584	0...1200 °C 32...2192 °F	5
TC S Pt10%Rh-Pt IEC584	0...1600 °C 32...2912 °F	6
0...50mV linear	Engineering units	7
10...50mV linear	Engineering units	8
mV "Custom" scale	On request	9

Output configuration	L
P.I.D.	control OP1 / alarm AL2 on OP2 control OP2 / alarm AL2 on OP1
On - Off	control OP1 / alarm AL2 on OP2 control OP2 / alarm AL2 on OP1
Heat / Cool action	control OP1-OP3 / alarm AL2 on OP2 control OP1-OP2 / alarm AL2 on OP3 control OP2-OP3 / alarm AL2 on OP1

Single control action type	Heat/Cool double control action	M
Reverse	Linear cool	0
Direct	On-Off cool	1

AL2 type and function	N
Disabled	0
Sensor break/Loop break alarm	1
Absolute	active high active low
Deviation	active high active low
Band	active out active in
Heater break by CT (if present)	active during ON output state active during OFF output state

If not differently specified the controller will be supplied with standard version

Model: M2 3600-0000