

# Double action controller with analogue output 1/4 DIN - 96 x 96 mm gammadue® series Q3 line



## Analogue control within everyone's reach

Including Auto/Man selection  
and digital inputs for external  
activation of:

- Stored Setpoints
  - Timer function
  - Setpoint programmable profile
- the gammadue® Q3 line  
is simple, yet is suitable to satisfy  
almost all control needs:
- time proportioning
  - analogue
  - single or double action
  - valve drive

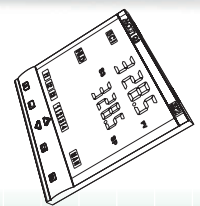
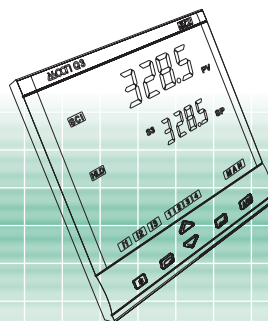
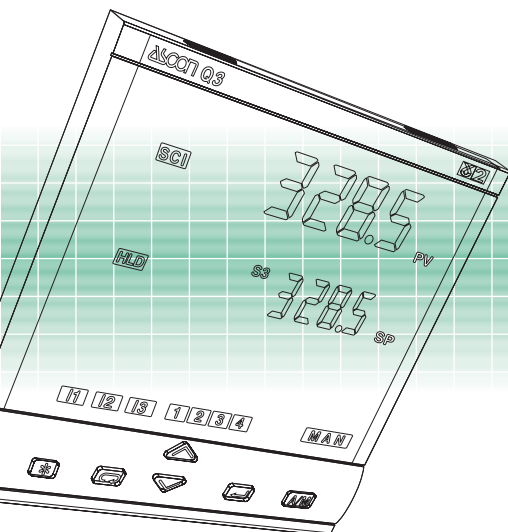

E

ISO 9001 Certified

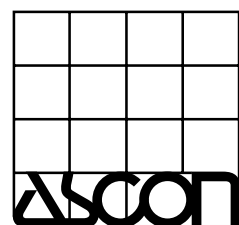



# gammadue®

the right solution to your needs

Your needs	Our solutions
Heaters failure	Heater break alarm with current transformer
Use of different actuators	Analogue output, heat/cool (linear, water, oil), valve control output
Easy replacement and quick start-up	Configuration by simple to use codes
Correct tuning for any condition	Automatic selection between two different tuning methods
Alarm signalling	Absolute, band and deviation alarms, Latching/Blocking
Interfacing with other devices	Serial communications at 9,600 baud Modbus/Jbus protocol, analogue retransmission output, Remote Setpoint and 3 digital inputs
Frequent Setpoint change	Two stored Setpoints selected by keypad, serial communications or digital inputs
Quick learning	Every model has the same operating method
Ergonomic compatibility with other devices	Two colours: beige or darkgrey front panels
Environmental protection	IP65 front panel protection (indoor, dust and water protection)
Easy to use	Ergonomic keypad, clear and comprehensive display
Noise immunity	Electromagnetic compatibility
Universal input signals, linear as well as non-linear	Configurable input (TC, RTD, mA, Volt and $\Delta T$ , infrared sensor, "custom" linearisation)
Costs reduction	Built-in Timer and Start-up functions
Reliability and safety	CE compatibility, ASCON is ISO 9001 certified, 3 years warranty
Technical support	Technical application assistance from ASCON sales and after sales service

## Resources Operating mode

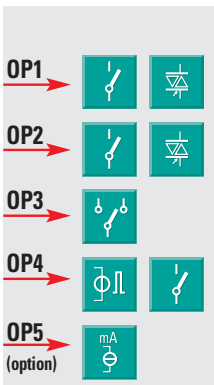
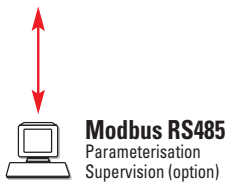
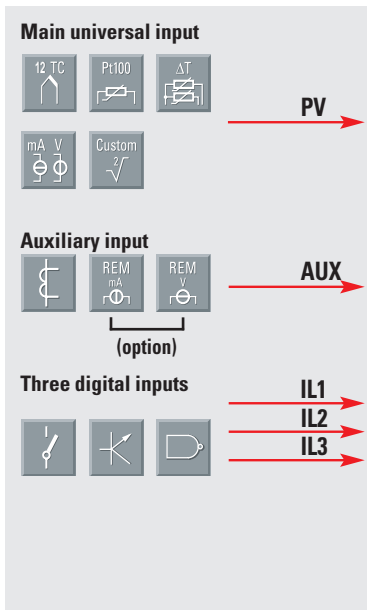

		Control		Alarms			Retransmission
		Control	Control	Alarms	Alarms	Alarms	PV/SP
1	Single action	OP1		OP2	OP3	OP5	
		OP4		OP1	OP2	OP3	OP5
		OP5		OP1	OP2	OP3	
4	Double action	OP1	OP2		OP3	OP5	
		OP1	OP4		OP2	OP3	OP5
		OP4	OP2	OP1		OP3	OP5
		OP1	OP5		OP2	OP3	
		OP5	OP2	OP1		OP3	
		OP5	OP4	OP1	OP2	OP3	
		OP5	OP4	OP1	OP2	OP3	
10	Valve (option)	OP1	OP2		OP3	OP5	



## Technical data

Features at env. 25°C	Description			
Total configurability	From keypad or serial communications, the user selects: type of input - associated functions and corresponding outputs - type of control algorithm - type of output and safe conditions - alarm types and functionality - control parameter values			
PV input for signal ranges see table 1)	Common characteristics	A/D converter with 50,000 points Update measurement time: 0.2 s Sampling time: 0.5 s Input shift: -60...+60 digit Input filter: 1...30 s (OFF= 0)		
	Accuracy	0.25% ±1 digit (T/C and RTD) 0.1% ±1 digit (mA and mV)	Between 100 and 240V~error is minimal	
	Resistance thermometer (for ΔT: R1+R2 must be <320Ω)	Pt100Ω at 0°C (IEC 751) °C/°F selectable	2 or 3 wires connection Burnout (with any combination)	Line: 20Ω max. (3wires) Thermal drift: 0.35°C/10°C T <sub>Env</sub> 0.35°C/10Ω line resist.
	Thermocouple	L,J,T,K,S,R,B,N,E,W3,W5 (IEC 584) °C/°F selectable	Internal cold junction compensation with NTC Error 1°C/20°C ± 0.5°C Burnout	Line: 150 Ω max. Thermal drift <2μV/°C T <sub>Env</sub> <5μV/10Ω line resist.
	DC input (current)	0/4...20mA, 2.5Ω ext. shunt R <sub>j</sub> >10MΩ	Burnout. Engineering units, floating decimal point, configurable Low Range -999...9,999 High Range -999...9,999 100 digits minimum	Input drift: <0.1%/20°C T <sub>Env</sub> <5μV/10Ω line resist.
	DC input (voltage)	0/10...50mV, R <sub>j</sub> >10MΩ		
Auxiliary inputs	Remote Setpoint (option) Not isolated accuracy 0.1%	Current 0/4...20mA R <sub>j</sub> = 30Ω Voltage 1-5/0-5/0-10V R <sub>j</sub> = 300kΩ	Bias in engineering units and ±range Ratio from -9.99...+99.99 Local + Remote	
	CT current transformer	50 or 100mA input hardware selectable	Current visualization 10...200 A with 1A resolution and Heater break alarm	
Digital inputs 3 logic	The closure of the external contact produces any of the following actions	Auto/Man mode change, Local/Remote Setpoint mode change, Stored Setpoints activation, keypad lock, measure hold Timer activation, program run/hold (if options installed)		
Operating modes	1 single or double action P.I.D. loop or ON/OFF with 1, 2 or 3 alarms			
Control mode	Algorithm	P.I.D. with overshoot control or ON/OFF P.I.D. with valve algorithm, for controlling motorised positioners		
	Proport. band (P)	0.5...999.9%		
	Integral time (I)	0.1...100.0 min		
	Derivative time (D)	0.01...10.00 min		
	Error dead band	0.1...10.0 digit		
	Overshoot control	0.01...1.00		
	Manual reset	0.0...100.0%		
	Cycle time (Time proportioning only)	1...200 s		
	Control output high limit	10.0...100.0%		
	Soft-start output value	0.1...100.0% User Enabled/ Disabled		
	Output safety value	0.0...100.0% (-100.0...100.0% for Heat/Cool)		
	Control output hysteresis	0.1...10.0%		
	Dead band	-10.0...10.0%		
	Relative cool gain	0.1...10.0		
Cycle time (Time proportional only)	1...200 s			
Cool output high limit	10.0...100.0%			
Cool output hysteresis	0.1...10.0%			
Motor travel time	15...600 s			
Motor minim. step	by 0.1...5.0%			
	Valve PID algorithm without feedback potentiometer			

Input type	Scale range
RTD Pt100 IEC751	-99.9...300.0 °C
	-99.9...572.0 °F
RTD Pt100 IEC751	-200...600 °C
	-328...1,112 °F
TC L Fe-Const DIN43710	0...600 °C 32...1,112 °F
TC J Fe-CU45% NI IEC584	0...600 °C 32...1,112 °F
TC T Cu-CuNi	-200...400 °C
	-328...752 °F
TC K Cromel- Alumel IEC584	0...1,200 °C 32...2,192 °F
TC S Pt10% Rh-Pt IEC584	0...1,600 °C 32...2,912 °F
TC R Pt13% Rh Pt IEC584	0...1,600 °C 32...2,912 °F
TC B Pt30% Rh Pt 6% IEC584	0...1,800 °C 32...3,272 °F
TC N Nicrosil- Nisil IEC584	0...1,200 °C 32...2,192 °F
TC E Ni10% CR CuNi IEC584	0...600 °C 32...1,112 °F
TC NI NiMo18%	0...1,100 °C 32...2,012 °F
TC W3%Re W25%Re	0...2,000 °C 32...3,632 °F
TC W5%Re W26%Re	0...2,000 °C 32...3,632 °F
0/4...20 mA 0/10...50 mV mV Custom scale	Configurable engineering units mA, mV, V, bar, psi, Rh, ph On request

Table 1: PV input

## Special functions

To improve the instrument performance and to reduce the wiring and installation costs, two special functions are available:

### - Start-up

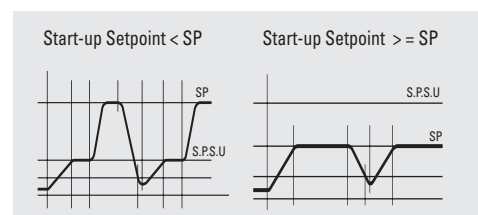

### - Timer

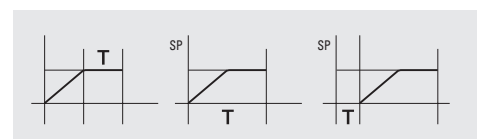

The use of these functions avoids additional device installation (e.g. external timer), therefore allowing a significant costs reduction.

Moreover there are:

- **Keypad lock/unlock** function, to avoid incorrect operator actions
- **Outputs lock/unlock** function, at any moment it is possible to stop the control action, but not the process variable display, without switching-off the power supply.

## Technical data

Features at env. 25°C	Description		
OP1-OP2 outputs	SPST relay N.O., 2A/250V~ for resistive load Triac, 1A/250V~ for resistive load		
OP3 output	SPDT relay N.O., 2A/250V~ for resistive load		
OP4 output	SSR drive not isolated: 0/5V-, ± 10%, 30mA max. SPST relay N.O., 2A/250V~ for resistive load		
OP5 (option) analogue control output	Control or PV/SP retransmission	Galvanically isolated: 500V~/1min. Resolution: 12 bit Accuracy: 01%  In current: 0/4...20mA, 750Ω/15V max.	
AL1- AL2 - AL3 alarms	Hysteresis	0.1...10.0%	
	Action	Active high	Action type
		Active low	Deviation threshold ± range Band threshold 0...range Absolute threshold, whole range
		Special functions	Sensor break, Heater break and Loop break detection
			Acknowledge (latching), activation inhibit (blocking) Connected to Timer or program (if options installed)
Setpoint	Local Local plus two stored (tracking or Stand-by) Local and Remote Local with trim Remote with trim Programmable	Up and down ramps 0.1...999.9 digit/min. (OFF=0)  Low limit: from low range to high limit High limit: from low limit to high range	
Programmable Setpoint (option)	1 program, 8 segments 1 initial and 1 end, from 1 to 9,999 cycles or continuous cycling (OFF) Start, stop, hold, etc. activated from the keypad, digital input and serial comm.s		
Special functions (options)	Timer	Automatic start at the power on, manual start by keypad, Digital inputs or serial comm.s Setting time: 1...9,999 s/min. Stand-by Setpoint: from Setpoint low limit to Setpoint high limit	
	Start-up	Start-up Setpoint: from Setpoint low limit to Setpoint high limit Hold time: 0...500 min. Control output high limit: 5.0...100.0%	
One-shot Fuzzy-Tuning	Depending on the process condition, the controller applies the best method	Step response Natural frequency	
Auto/Man selection	Standard with bumpless function, by keypad, digital input or serial communications		
Serial comm.s (option)	RS 485 isolated, Modbus/Jbus protocol 1,200, 2,400, 4,800, 9,600 bit/s, three wires		
Auxiliary power supply	+24V- ±20%, 30 mA max. for external transmitter supply		
Operational safety	Measure input	Detection of out of range, short circuit or sensor break with automatic activation of the safety strategies and alerts on display	
	Control output	Safety value: -100%...100%	
	Parameters	A non volatile memory stores for unlimited time all the configuration and parameter values	
	Password	Password to access the configuration and parameters data, keypad lock, outputs lock	
General characteristics	Power supply (fuse protected)	100-240~ (-15% + 10%) 50/60Hz or 24~ (-15% + 25%) 50/60Hz and 24V- (analogue) (-15% + 25%)	Power consumption 4W max.
	Safety	Compliance EN61010-1 (IEC 1010-1), installation class 2 (2,500V), pollution class 2, class II instrument	
	Electromagnetic compatibility	Compliance to the CE standards for industrial system and equipment	
	Approval UL and cUL	File E176452	
	Protection EN60529 (IEC529)	IP65 front panel	
Dimensions	1/4 DIN - 96 x 96, depth 110 mm, weight 470g approx.		

## Electrical wirings

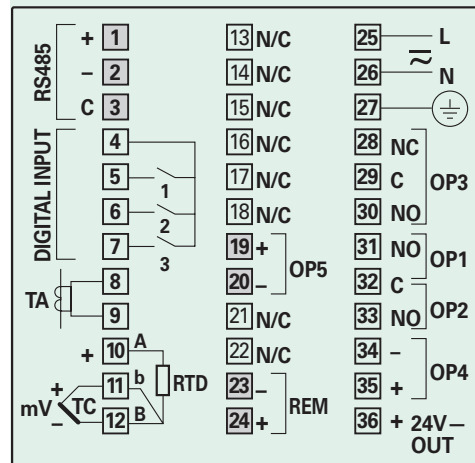

## Fuzzy-Tuning

Two methods of tuning are available:

- **Auto-Tuning "one shot"**
- **Natural frequency "one shot"**

The **Fuzzy-Tuning** automatically selects one of the two methods which assure the best result for each condition.

The **Auto-Tuning** method works best on the step response basis.

When activated, if a deviation exists between the Setpoint and process variable larger than 5% of scale range, the controller modifies the output value. Then, in a short time, it calculates the PID parameters and the new algorithm is operational immediately.

The main advantages of this method are fast calculation and quick implementation.

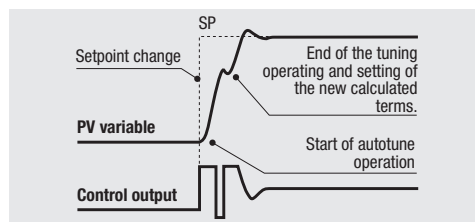

The **Natural frequency** method works best when the process variable is very near to the Setpoint. When activated, it causes a process oscillation around the Setpoint value.

The main advantage of this method is a reduced disturbance to the process.

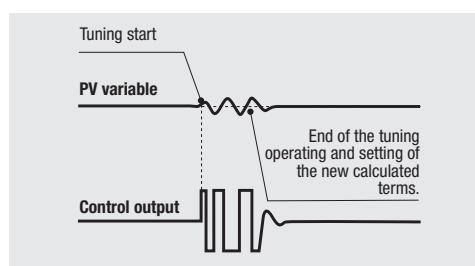

## Ordering codes

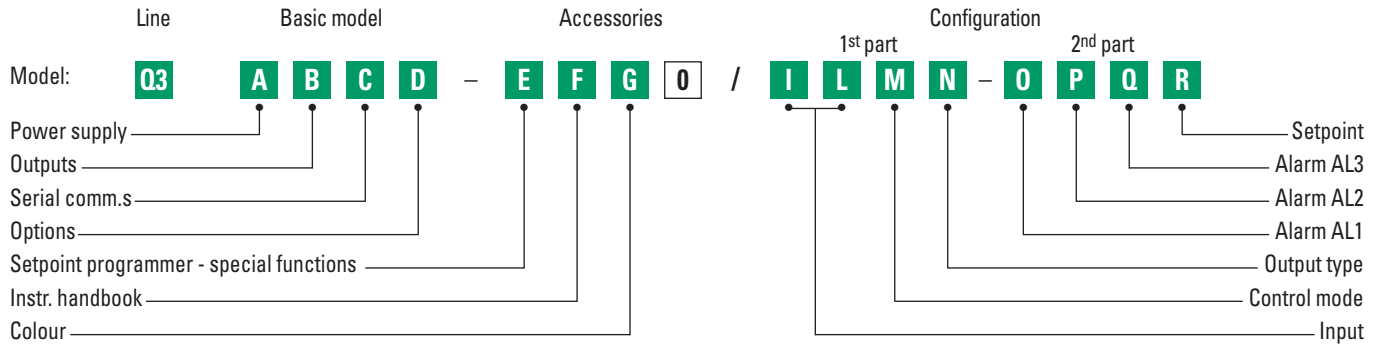

Power supply		<b>A</b>
100-240V~ (-15% +10%)		3
24V~ (-25% +12%) or 24V~ (-15% +25%)		5
OP1-OP2-OP4 outputs		<b>B</b>
Relay-Relay-SSR Drive		1
Triac-Triac-SSR Drive		5
Relay-Relay-Relay		9
Serial communications		<b>C</b>
Not fitted		0
RS 485 Modbus/Jbus SLAVE		5
Options		<b>D</b>
None		0
Valve drive output (no potentiometer)		2
Analogue output + Remote Setpoint		5
Valve drive output + Analogue output (retr.) + Remote Setpoint		7
Setpoint programmer - special functions		<b>E</b>
Not fitted		0
Start-up + Timer		2
One "8 segments" program		3
Instruction handbook		<b>F</b>
Italian-English (std)		0
French-English		1
German-English		2
Spanish-English		3
Front case colour		<b>G</b>
Dark (std)		0
Beige		1

Input type		Range scale		<b>I</b>	<b>L</b>
RTD Pt100 IEC751		-99.9...300.0 °C	-99.9...572.0 °F	0	0
RTD Pt100 IEC751		-200...600 °C	-328...1,112 °F	0	1
TC L Fe-Const DIN43710		0...600 °C	32...1,112 °F	0	2
TC J Fe-Cu45% Ni IEC584		0...600 °C	32...1,112 °F	0	3
TC T Cu-CuNi		-200...400 °C	-328...752 °F	0	4
TC K Chromel -Alumel IEC584		0...1,200 °C	32...2,192 °F	0	5
TC S Pt10%Rh-Pt IEC584		0...1,600 °C	32...2,912 °F	0	6
TC R Pt13%Rh-Pt IEC584		0...1,600 °C	32...2,912 °F	0	7
TC B Pt30%Rh-Pt Pt6%Rh IEC584		0...1,800 °C	32...3,272 °F	0	8
TC N Nicrosil-Nisil IEC584		0...1,200 °C	32...2,192 °F	0	9
TC E Ni10%CR-CuNi IEC584		0...600 °C	32...1,112 °F	1	0
TC Ni NiMo 18%		0...1,100 °C	32...2,012 °F	1	1
TC W3%Re-W25%Re		0...2,000 °C	32...3,632 °F	1	2
TC W5%Re-W26%Re		0...2,000 °C	32...3,632 °F	1	3
0...50mV linear	Engineering units			1	4
10...50mV linear	Engineering units			1	5
mV "Custom" scale	On request			1	6
Control mode				<b>M</b>	
ON-OFF reverse action					0
ON-OFF direct action					1
P.I.D. single reverse action					2
P.I.D. single direct action					3
P.I.D. double action	Linear cool output				4
	ON-OFF cool output				5
	Water cool output				6
	Oil cool output				7
Output type - Single action		Output type - Double action		<b>N</b>	
Relay	Heat Relay, Cool Relay				0
Digital	Heat Relay, Cool Digital				1
Analogue	Heat Digital, Cool Relay				2
Valve drive	Heat Relay, Cool Analogue				3
	Heat Analogue, Cool Relay				4
	Heat Digital, Cool Analogue				5
	Heat Analogue, Cool Digital				6
AL1-AL2-AL3 type and function				<b>O-P-Q</b>	
Disabled or (only AL3) used by Timer or related to the program					0
Sensor break/Loop break alarm					1
Absolute	active high				2
	active low				3
Deviation	active high				4
	active low				5
Band	active out				6
	active in				7
Heater break by CT	active during ON output state				8
	active during OFF output state				9
Setpoint type				<b>R</b>	
Local only					0
Local and 2 tracking stored Setpoints					1
Local and 2 Stand-by stored Setpoints					2
Local and Remote (if option installed)					3
Local with trim (only with remote Setpoint)					4
Remote with trim (if option installed)					5
Time programmable (if option installed)					6

**If not differently specified the controller will be supplied with standard version**  
**Model: Q3 3100-0000**



S E R I E S

**ASCON spa**  
20021 Bollate  
(Milano) Italy  
Via Falzarego, 9/11  
Tel. +39 02 333 371  
Fax +39 02 350 4243  
<http://www.ascon.it>  
e-mail [info@ascon.it](mailto:info@ascon.it)

#### **ASCON FRANCE**

2 bis, Rue Paul Henri Spaak  
ST. THIBAUT DES VIGNES  
F-77462 LAGNY SUR  
MARNE - Cedex  
Tél. +33 (0) 1 64 30 62 62  
Fax +33 (0) 1 64 30 84 98  
e-mail  
[ascon.france@wanadoo.fr](mailto:ascon.france@wanadoo.fr)

#### **AGENCE SUD-EST**

Tél. +33 (0) 4 74 27 82 81  
Fax +33 (0) 4 74 27 81 71

#### **WORLDWIDE NETWORK OF DIRECT SALES CENTRES, DISTRIBUTORS AND VARs**

##### **Europe**

Belgium, Cyprus, Croatia,  
Czech Rep, Finland, France,  
Germany, Great Britain, Greece,  
Holland, Ireland, Norway, Poland,  
Portugal, Romania, Russia,  
Slovenia, Spain, Sweden,  
Switzerland, Turkey, Ukain

##### **Americas**

Argentina, Brazil, Canada, Chile,  
Colombia, Ecuador, Peru, United States

##### **Over the world**

Australia, China, Egypt, Hong Kong,  
India, Iran, Israel, Malaysia,  
New Zealand, Pakistan, Saudi Arabia,  
Singapore, Taiwan, Thailand,  
South Africa & South East Africa

