

Heat-Cool temperature controller 1/8 DIN - 48 x 96 mm gammadue® series X1 line



Cost effective solutions

Ideal for Heat/Cool control, with the capability to check the load current by current transformer.

Three relay outputs (one SPDT) and an analogue retransmission output, powerful Timer and Start-up special functions. The X1 line, the simplest of the gammadue® 48x96 series, is very cost-effective instrument allowing you to buy only what you really need to satisfy your requirements.

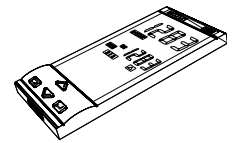
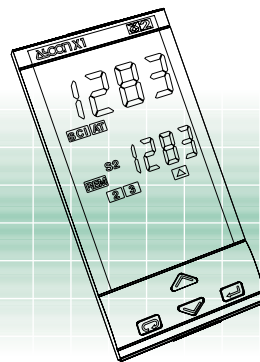
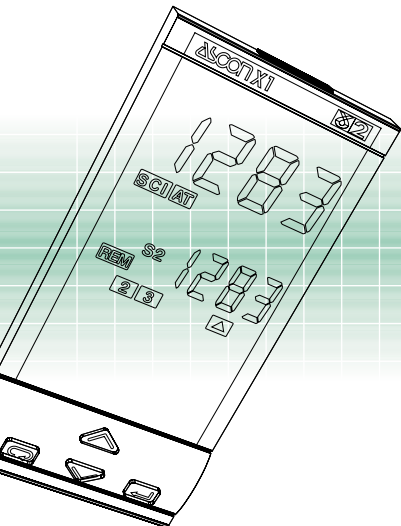

E

ISO 9001 Certified

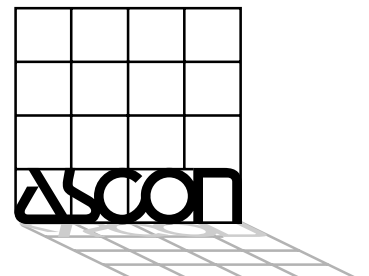



gammadue[®]

the right solution to your needs

Your needs	Our solutions
Heaters failure	Heater break alarm with current transformer
Both heating and cooling functions with different medium	Heat/Cool (linear, water, oil) double action
Easy replacement and quick start-up	Configuration by simple to use codes
Correct tuning for any condition	Automatic selection between two different tuning methods
Alarm signalling	Absolute, band and deviation alarms, Latching/Blocking
Interfacing with other devices	Serial communications at 9600 baud Modbus/Jbus protocol, analogue retransmission output
Frequent Setpoint change	Two stored Setpoints selected by keypad or serial communications
Quick learning	Every model has the same operating method
Ergonomic compatibility with other devices	Two colours: beige or darkgrey front panels
Environmental protection	IP65 front panel protection (indoor, dust and water protection)
Easy to use	Ergonomic keypad, clear and comprehensive display
Noise immunity	Electromagnetic compatibility
Universal input signals, linear as well as non-linear	Configurable input (TC, RTD, mA, Volt and ΔT , infrared sensor, "custom" linearisation)
Costs reduction	Built-in Timer and Start-up functions
Reliability and safety	CE compatibility, ASCON is ISO 9001 certified, 3 years warranty
Technical support	Technical application assistance from ASCON sales and after sales service

Resources

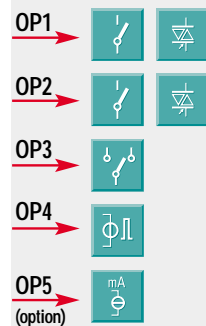
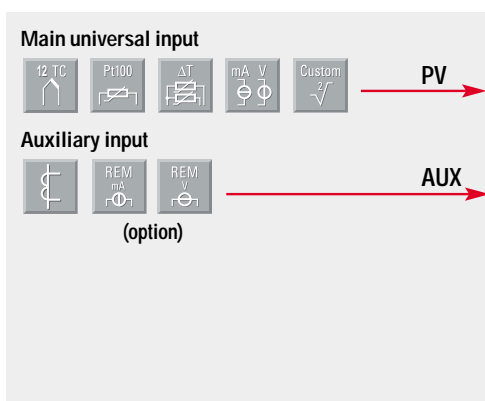

Setpoint



Special functions (option)



X1

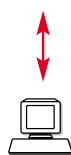

Modbus RS485
Parameterisation
Supervision
(option)

Fuzzy tuning with automatic selection



Operating mode

	Control	Alarms	Retransmission
			PV/SP
1	Single action	OP1	OP2 OP3 OP5
2	Single action	OP4	OP1 OP2 OP3 OP5
3	Double action	OP1 OP2	OP3 OP5
4	Double action	OP1 OP4	OP2 OP3 OP5
5	Double action	OP4 OP2	OP1 OP3 OP5

Technical data

Features at env. 25°C	Description			
Total configurability	From keypad or serial communications, the user selects: type of input - associated functions and corresponding outputs - type of control algorithm - type of output and safe conditions - alarm types and functionality - control parameter values			
PV input (for signal ranges see table 1)	Common characteristics	A/D converter with 50.000 points Update measurement time : 0.2 sec Sampling time : 0.5 sec Input shift: - 60... + 60 digit Input filter : 1...30 sec (OFF= 0)		
	Accuracy	0.25% ± 1 digit (T/C and RTD) 0.1% ± 1 digit (mA and mV)	Between 100 and 240V ~error is minimal	
	Resistance thermometer (for ΔT: R1+R2 must be <320Ω)	Pt100Ω at 0°C (IEC 751) °C/°F selectable	2 or 3 wire connection Burnout (with any combination)	Line: 20 Ω max (3wire) Thermal drift 0.35°C/10°C env. T. <0.35°C/10 Ω line exist.
	Thermocouple	L, J, T, K, S, R, B, N, E, W3, W5 (IEC 584) °C/°F selectable	Internal cold junction compensation with NTC Error 1°C/20°C ± 0.5°C Burnout	Line: 150 Ω max Thermal drift <2µV/°C env. T. <5µV/10 Ω line resist.
	DC input (current)	0/4...20mA, 2.5Ω ext. shunt Rj >10MΩ	Burnout. Engineering units, floating decimal point, configurable	Input drift: <0.1% / 20°C env. T. <5µV/10 Ω line resist.
	DC input (voltage)	0/10...50mV Rj >10MΩ	Low Range -999...9999 High Range -999...9999 100 digits minimum	
Auxiliary inputs	Remote Setpoint (option) Not isolated accuracy 0.1%	Current 0/4...20mA Rj = 30Ω Voltage 1-5/0-5/0-10V Rj = 300KΩ	Bias in engineering units and ± range Ratio from -9.99...+99.99 Local + Remote	
	CT current transformer	50 or 100mA input hardware selectable	Current visualization 10...200 A with 1A resolution and Heater break alarm	
Operating modes	1 single or double action P.I.D. loop or ON/OFF with 1, 2 or 3 alarms			
Control mode	Algorithm	P.I.D. with overshoot control or ON/OFF		
	Proport. band (P)	0.5...999.9%	User Enabled/Disabled	
	Integral time (I)	0.1...100.0 min		
	Derivative time (D)	0.01...10.00 min		
	Error dead band	0.1...10.0 digit		
	Overshoot control	0.01...1.00	Single action PID algorithm	
	Manual reset	0.0...100.0%		
	Cycle time (Time proportional only)	1...200 sec		
	Control output high limit	10.0...100.0%		
	Soft-start output value	0.1...100.0%		User Enabled/Disabled
	Output safety value	0.0...100.0% (-100.0...100.0% for Heat/Cool)	ON/OFF algorithm	
	Control output hysteresis	0.1...10.0%		
	Dead band	-10.0...10.0%		
Relative cool gain	0.1...10.0			
Cycle time (Time proportional only)	1...200 sec	Double action PID algorithm (Heat/Cool) with overlap		
Cool output high limit	10.0...100.0%			
Cool output hysteresis	0.1...10.0%			
OP1-OP2 outputs	SPST relay N.O., 2A/250V~ for resistive load Triac, 1A/250V~ for resistive load			
OP3 output	SPDT relay N.O., 2A/250V~ for resistive load			
OP4 output	SSR drive not isolated: 0/5V-, ± 10%, 30mA max.			

Input type	Scale range
RTD Pt100 IEC751	-99.9...300.0 °C
	-99.9...572.0 °F
RTD Pt100 IEC751	-200...600 °C
	-328...1112 °F
TC L Fe-Const DIN43710	0...600 °C 32...1112 °F
TC J Fe-CU45% NI IEC584	0...600 °C 32...1112 °F
TC T Cu-CuNi	-200...400 °C
	-328...752 °F
TC K Cromel- Alumel IEC584	0...1200 °C 32...2192 °F
TC S Pt10% Rh-Pt IEC584	0...1600 °C 32...2912 °F
TC R Pt13% Rh Pt IEC584	0...1600 °C 32...2912 °F
TC B Pt30% Rh Pt 6% IEC584	0...1800 °C 32...3272 °F
TC N Nicrosil- Nisil IEC584	0...1200 °C 32...2192 °F
TC E Ni10% CR CuNi IEC584	0...600 °C 32...1112 °F
TC Ni-NiMo18%	0...1100 °C 32...2012 °F
TC W3%Re W25%Re	0...2000 °C 32...3632 °F
TC W5%Re W26%Re	0...2000 °C 32...3632 °F
0/4...20 mA 0/10...50 mV mV Custom scale	Configurable engineering units mA, mV, V, bar, psi, Rh, ph On request

Table 1: PV input

Special functions

To improve the instrument performance and to reduce the wiring and installation costs, two special functions are available:

- Start-up

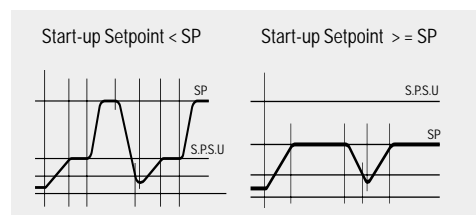

- Timer

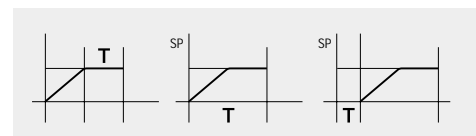

The use of these functions avoids additional device installation (e.g. external timer), therefore allowing a significant costs reduction.

Moreover there are:

- **Keypad lock/unlock** function, to avoid incorrect operator actions
- **Outputs lock/unlock** function, at any moment it is possible to stop the control action, but not the process variable display, without switching-off the power supply.

Technical data

Features at env. 25°C	Description		
OP5 (option) analogue output	PV/SP retransmission	Galvanically isolated: 500V~ /1min Resolution: 12 bit Accuracy: 0.1%	In current: 0/4...20mA, 750Ω /15V max
AL1- AL2 - AL3 alarms	Hysteresis	0.1...10.0%	
	Action	Active high	Action type
		Active low	Deviation threshold ± range
		Special functions	Band threshold 0...range
		Absolute threshold, whole range	
		Sensor break, Heater break and Loop break detection	
		Acknowledge (latching), activation inhibit (blocking)	
		Connected to Timer or program (if options installed)	
Setpoint	Local	Up and down ramps 0.1...999.9 digit/min.	
	Local plus two stored (tracking or Stand-by)	(OFF=0)	
	Local and Remote	Low limit:	
	Local with trim	High limit:	
	Remote with trim	from low range to high limit	High limit:
Special functions (options)	Timer	Automatic start at the power on, manual start by keypad or serial comm.s	
		Setting time: 1...9999 sec/min	
	Start-up	Stand-by Setpoint: from Setpoint low limit to Setpoint high limit	
Start-up Setpoint: from Setpoint low limit to Setpoint high limit			
One-shot Fuzzy-Tuning	Depending on the process condition, the controller applies the best method	Step response	
		Natural frequency	
Serial comm.s (option)	RS 485 isolated, Modbus/Jbus protocol 1200, 2400, 4800, 9600 bit/sec, three wires		
Auxiliary power supply	+24V- ±20%, 30 mA max for external transmitter supply		
Operational safety	Measure input	Detection of out of range, short circuit or sensor break with automatic activation of the safety strategies and alerts on display	
	Control output	Safety value: -100%...100%	
	Parameters	A non volatile memory stores for unlimited time all the configuration and parameter values	
	Password	Password to access the configuration and parameters data, keypad lock, outputs lock	
General characteristics	Power supply (fuse protected)	100-240~ (-15% + 10%) 50/60Hz or 24~ (-15% + 25%) 50/60Hz and 24V- (analogue) (-15% + 25%)	Power consumption 4W max
	Safety	Compliance EN61010-1 (IEC 1010-1), installation class 2 (2500V), pollution class 2, class II instrument	
	Electromagnetic compatibility	Compliance to the CE standards for industrial system and equipment	
	Approval UL and cUL	File E176452	
	Protection EN60529 (IEC529)	IP65 front panel	
Dimensions	1/8 DIN - 48 x 96, depth 110 mm, weight 250g appr.		

Electrical wirings

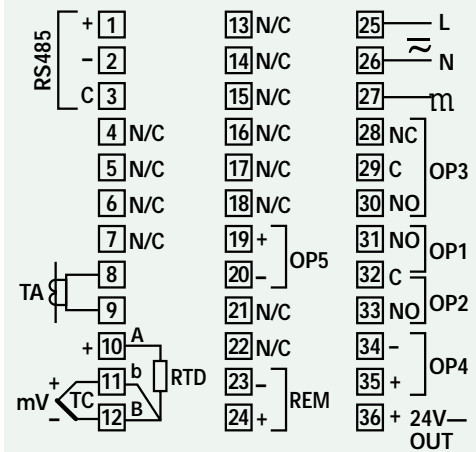

Fuzzy-Tuning

Two methods of tuning are available:

- **Auto-Tuning "one shot"**
- **Natural frequency "one shot"**

The **Fuzzy-Tuning** automatically selects one of the two methods which assure the best result for each condition.

The **Auto-Tuning** method works best on the step response basis.

When activated, if a deviation exists between the Setpoint and process variable larger than 5% of scale range, the controller modifies the output value. Then, in a short time, it calculates the PID parameters and the new algorithm is operational immediately.

The main advantages of this method are fast calculation and quick implementation.

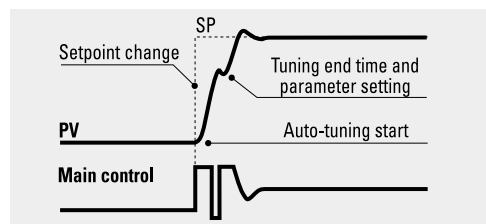

The **Natural frequency** method works best when the process variable is very near to the Setpoint.

When activated, it causes a process oscillation around the Setpoint value.

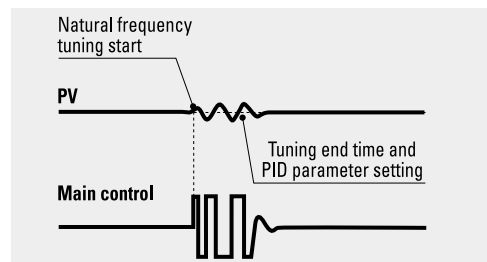

Ordering codes

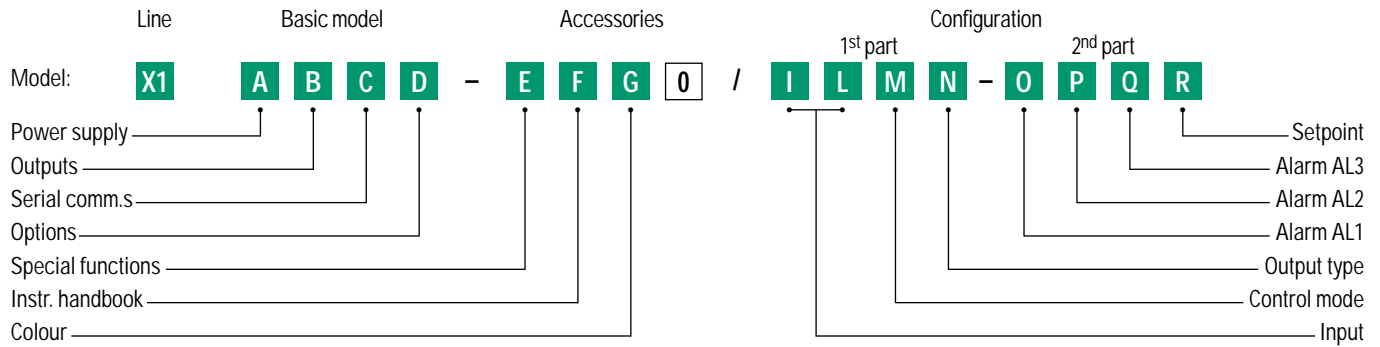

Power supply	A
100-240V- (-15% +10%)	3
24V- (-25% +12%) or 24V- (-15% +25%)	5
OP1-OP2 outputs	B
Relay-Relay	1
Triac-Triac	5
Serial communications	C
Not fitted	0
RS 485 Modbus/Jbus SLAVE	5
Options	D
None	0
Analogue output + Remote Setpoint	5
Special functions	E
Not fitted	0
Start-up + Timer	2
Instruction handbook	F
Italian-English (std)	0
French-English	1
German-English	2
Spanish-English	3
Front case colour	G
Dark (std)	0
Beige	1

Input type	Range scale	I	L
RTD Pt100 IEC751	-99.9...300.0 °C -99.9...572.0 °F	0	0
RTD Pt100 IEC751	-200...600 °C -328...1112 °F	0	1
TC L Fe-Const DIN43710	0...600 °C 32...1112 °F	0	2
TC J Fe-Cu45% Ni IEC584	0...600 °C 32...1112 °F	0	3
TC T Cu-CuNi	-200...400 °C -328...752 °F	0	4
TC K Chromel -Alumel IEC584	0...1200 °C 32...2192 °F	0	5
TC S Pt10%Rh-Pt IEC584	0...1600 °C 32...2912 °F	0	6
TC R Pt13%Rh-Pt IEC584	0...1600 °C 32...2912 °F	0	7
TC B Pt30%Rh-Pt	0...1800 °C 32...3272 °F	0	8
Pt6%Rh IEC584			
TC N Microsil-Nisil IEC584	0...1200 °C 32...2192 °F	0	9
TC E Ni10%CR-CuNi IEC584	0...600 °C 32...1112 °F	1	0
TC Ni-NiMo 18%	0...1100 °C 32...2012 °F	1	1
TC W3%Re-W25%Re	0...2000 °C 32...3632 °F	1	2
TC W5%Re-W26%Re	0...2000 °C 32...3632 °F	1	3
0...50mV linear	Engineering units	1	4
10...50mV linear	Engineering units	1	5
mV "Custom" scale	On request	1	6
Control mode			M
ON-OFF reverse action			0
ON-OFF direct action			1
P.I.D. single reverse action			2
P.I.D. single direct action			3
P.I.D. double action	Linear cool output		4
	ON-OFF cool output		5
	Water cool output		6
	Oil cool output		7
Output type - Single action	Output type - Double action		N
Relay	Heat Relay, Cool Relay		0
Digital	Heat Relay, Cool Digital		1
	Heat Digital, Cool Relay		2
AL1-AL2-AL3 type and function			O-P-Q
Disabled or (only AL3) used by Timer			0
Sensor break/Loop break alarm			1
Absolute	active high		2
	active low		3
Deviation	active high		4
	active low		5
Band	active out		6
	active in		7
Heater break by CT	active during ON output state		8
	active during OFF output state		9
Setpoint type			R
Local only			0
Local and 2 tracking stored Setpoints			1
Local and 2 Stand-by stored Setpoints			2
Local and Remote			3
Local with trim			4
Remote with trim			5

**If not differently specified the controller will be supplied with standard version
 Model: X1 3100-0000**



S E R I E S

ASCON spa
20021 Bollate
(Milano) Italy
Via Falzarego, 9/11
Tel. +39 02 333 371
Fax +39 02 350 4243
<http://www.ascon.it>
e-mail info@ascon.it

ASCON FRANCE

2 bis, Rue Paul Henri Spaak
ST. THIBAUT DES VIGNES
F-77462 LAGNY SUR
MARNE - Cedex
Tél. +33 (0) 1 64 30 62 62
Fax +33 (0) 1 64 30 84 98
e-mail
ascon.france@wanadoo.fr

AGENCE SUD-EST

Tél. +33 (0) 4 74 27 82 81
Fax +33 (0) 4 74 27 81 71

**WORLDWIDE NETWORK OF
DIRECT SALES CENTRES,
DISTRIBUTORS AND VARs**

Europe

Belgium, Cyprus, Croatia,
Czech Rep, Finland, France,
Germany, Great Britain, Greece,
Holland, Ireland, Norway, Poland,
Portugal, Romania, Russia,
Slovenia, Spain, Sweden,
Switzerland, Turkey, Ukrain

Americas

Argentina, Brazil, Canada, Chile,
Colombia, Ecuador, Peru, United States

Over the world

Australia, China, Egypt, Hong Kong,
India, Iran, Israel, Malaysia,
New Zealand, Pakistan, Saudi Arabia,
Singapore, Taiwan, Thailand,
South Africa & South East Africa

