

Hot runner temperature controller

1/16 DIN - 48 x 48



ASCON spa

ISO 9001
Certified

M2 line

User manual • M.I.U.M2 -2/03.01 • Cod. J30-478-1AM2 IE



ASCON spa
20021 Bollate
(Milan) Italy
via Falzarego, 9/11
Tel. +39 02 333 371
Fax +39 02 350 4243
<http://www.ascon.it>
e-mail sales@ascon.it



Hot runner temperature controller

1/16 DIN - 48 x 48

M2 line

CE

UL US
LISTED

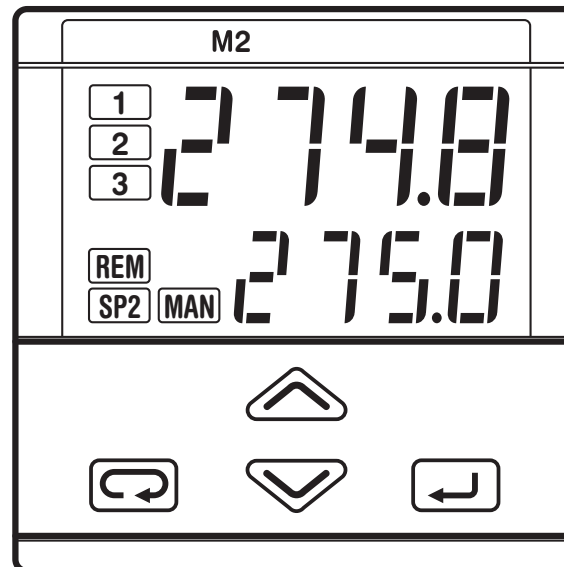



NOTES

ON ELECTRIC SAFETY AND ELECTROMAGNETIC COMPATIBILITY.

Please, read carefully these instructions before proceeding with the installation of the controller.

Class II instrument, rear panel mounting.

This controller has been designed with compliance to:

Regulations on electrical apparatus (appliance, systems and installations) according to the European Community directive 73/23/EEC amended by the European Community directive 93/68/EEC and the Regulations on the essential protection requirements in electrical apparatus EN61010-1 : 93 + A2:95.

Regulations on Electromagnetic Compatibility according to the European Community directive n089/336/EEC, amended by the European Community directive n° 92/31/EEC, 93/68/EEC, 98/13/EEC

and the following regulations:

Regulations on RF emissions

EN61000-6-3 : 2001 residential environments

EN61000-6-4 : 2001 industrial environments

Regulation on RF immunity

EN61000-6-2 : 2001 industrial equipment and system

It is important to understand that it's responsibility of the installer to ensure the compliance of the regulations on safety requirements and EMC.

This device has no user serviceable parts and requires special equipment and specialised engineers. Therefore, a repair can be hardly carried on directly by the user. For this purpose, the manufacturer provides technical assistance and the repair service for its Customers.

Please, contact your nearest Agent for further information.

All the information and warnings about safety and electromagnetic compatibility are marked with the   sign, at the side of the note.

TABLE OF CONTENTS

1	INSTALLATION	Page	4
2	ELECTRICAL CONNECTIONS	Page	8
3	PRODUCT CODING	Page	16
4	OPERATIONS	Page	20
5	AUTOMATIC TUNING	Page	38
6	SPECIAL FUNCTIONS	Page	40
7	TECHNICAL SPECIFICATIONS	Page	45

Resources
Operating mode

Main universal input

5 TC Pt100 ΔT mA V Custom PV

Auxiliary input (option)

AUX

Digital input (option)

IL



M2

OP1 OP2 OP3

Fuzzy tuning with automatic selection

Continuous tuning

Setpoint **Special functions**

LOC STAND BY [Crossed out] [Crossed out]

IL connected functions

[Hand icon] STAND BY [Crossed out] SP UP SP DOWN

(option)

	Control	Alarms		
1	Single action	OP1	OP2	OP3
2	Single action	OP2	OP1	OP3
3	Double action	OP1	OP3	OP2
4	Double action	OP1	OP2	OP3
5	Double action	OP2	OP3	OP1

1 ■ INSTALLATION

Installation must only be carried out by qualified personnel.

Before proceeding with the installation of this controller, follow the instructions illustrated in this manual and, particularly the installation precautions marked with the  symbol, related to the European Community directive on electrical protection and electromagnetic compatibility.



To prevent hands or metal touching parts that may be electrically live, **the controllers must be installed in an enclosure and/or in a cubicle.**

1.1 GENERAL DESCRIPTION

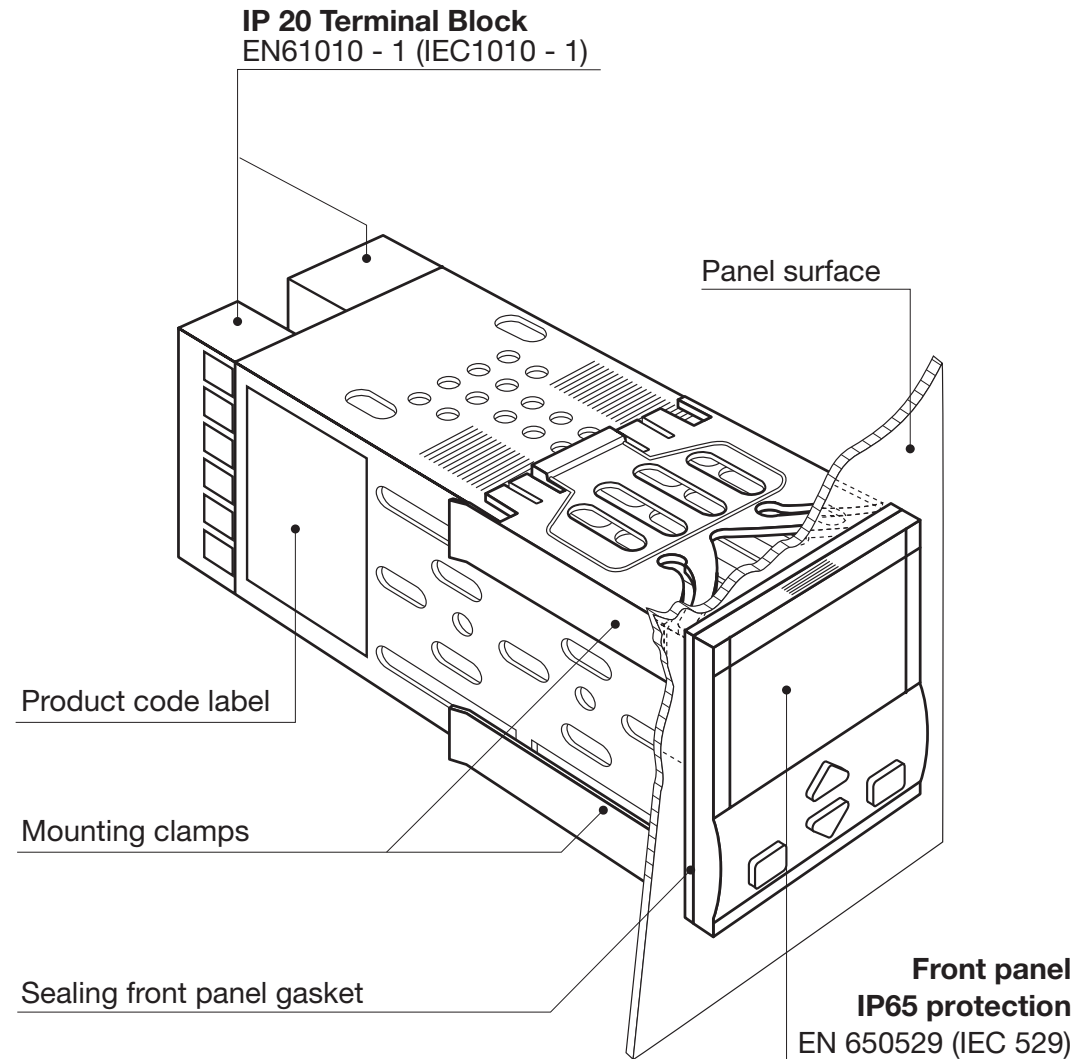

1.2 DIMENSIONAL DETAILS

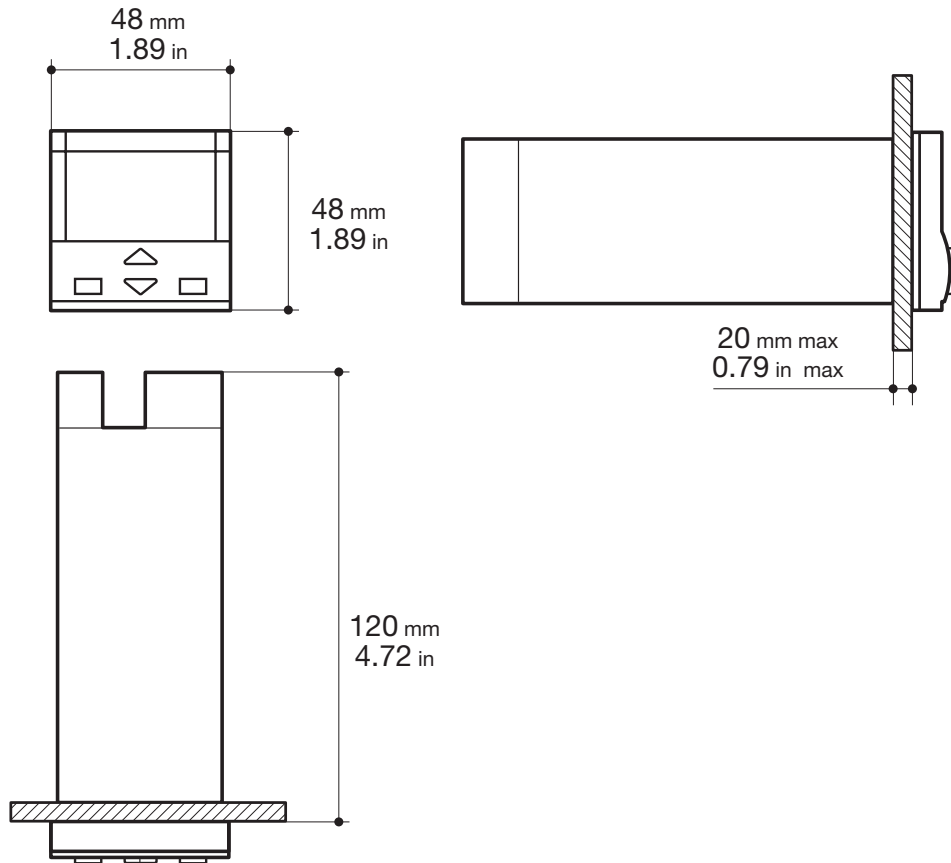

1.3 PANEL CUT-OUT

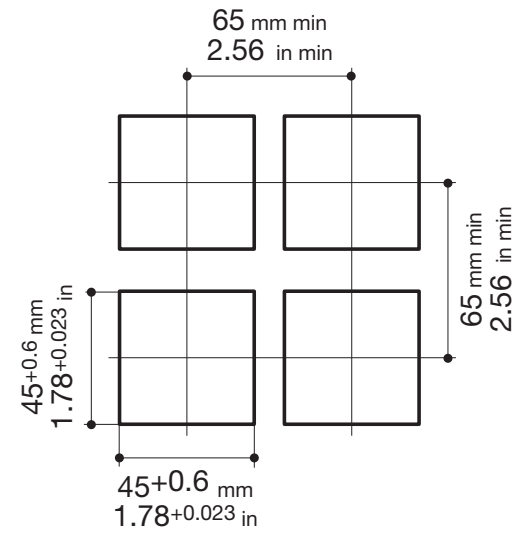

1.4 ENVIRONMENTAL RATINGS**Operating conditions**

Altitude up to 2000 m



Temperature 0... 50°C

%Rh

Relative humidity 5... 95 % non-condensing

Special conditions

Suggestions



Altitude > 2000 m

Use 24V~ supply version



Temperature >50°C

Use forced air ventilation

%Rh

Humidity > 95 %

Warm up



Conducting atmosphere

Use filter

Forbidden Conditions 

Corrosive atmosphere



Explosive atmosphere

1.5 PANEL MOUNTING [1]

1.5.1 INSERT THE INSTRUMENT

- 1 Prepare panel cut-out
- 2 Check front panel gasket position
- 3 Insert the instrument through the cut-out

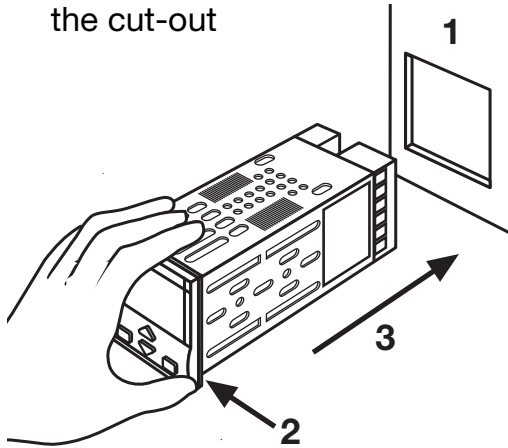

UL note

[1] For Use on a Flat Surface of a Type 2 and Type 3 'raintight' Enclosure.

1.5.2 INSTALLATION SECURING

- 1 Fit the mounting clamps
- 2 Push the mounting clamps towards the panel surface to secure the instrument

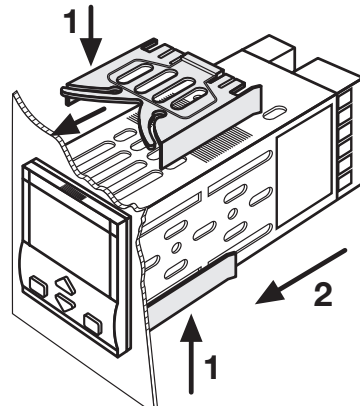

1.5.3 CLAMPS REMOVING

- 1 Insert the screwdriver in the clips of the clamps
- 2 Rotate the screwdriver

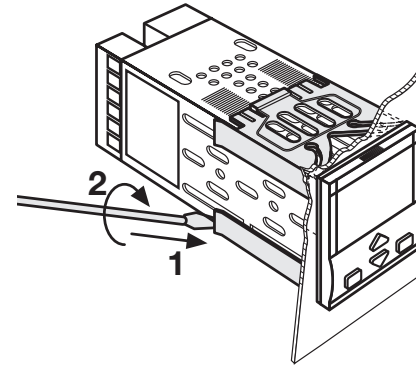

1.5.4 INSTRUMENT UNPLUGGING



- 1 Push and
- 2 pull to remove the instrument

Electrostatic discharges can damage the instrument

Before removing the instrument the operator must discharge himself to ground

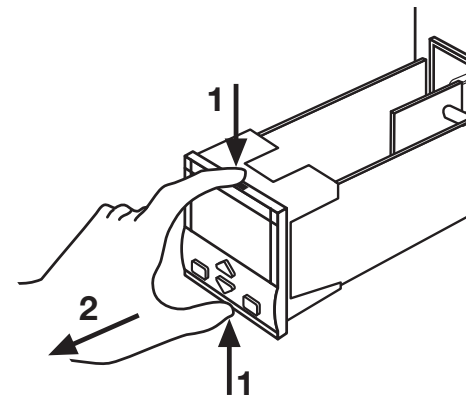

2 ELECTRICAL CONNECTIONS

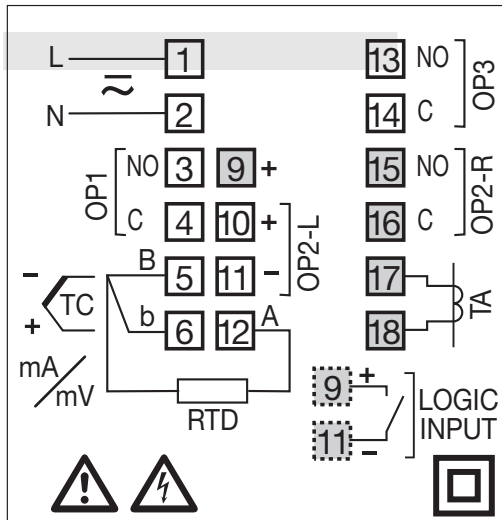

2.1 TERMINATION UNIT [1]

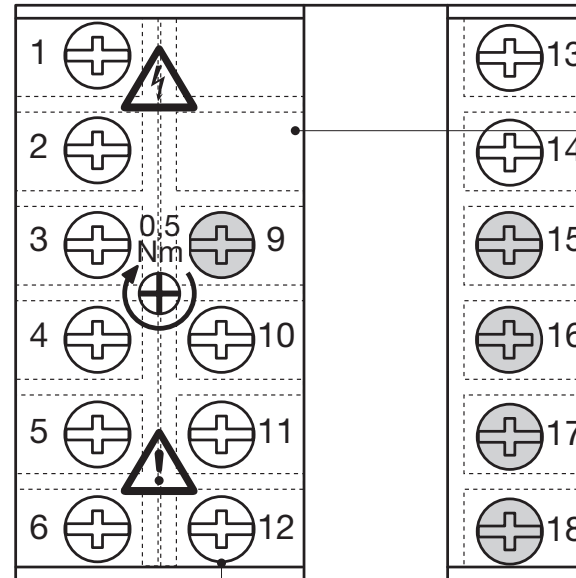



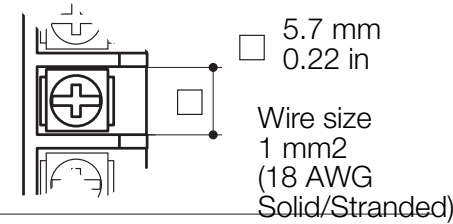

Rear terminal cover





UL note

[1] Use 60/70 °C copper (Cu) conductor only.

-  16 screw terminals
-  Option terminals
-  Holding screw 0.5 Nm
-  Positive screw driver PH1
-  Negative screw driver 0,8 x 4 mm

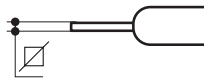
Terminals

-  Pin connector
∅ 1.4 mm
0.055 in max
-  Fork-shape
AMP 165004
∅ 5.5 mm - 0.21 in
-  Stripped wire
L 5.5 mm - 0.21 in

PRECAUTIONS

Despite the fact that the instrument has been designed to work in an harsh and noisy environmental (level IV of the industrial standard IEC 801-4), it is recommended to follow the following suggestions.



All the wiring must comply with the local regulations.

The supply wiring should be routed away from the power cables. Avoid to use electromagnetic contactors, power Relays and high power motors nearby. Avoid power units nearby, especially if controlled in phase angle

Keep the low level sensor input wires away from the power lines and the output cables.

If this is not achievable, use shielded cables on the sensor input, with the shield connected to earth.

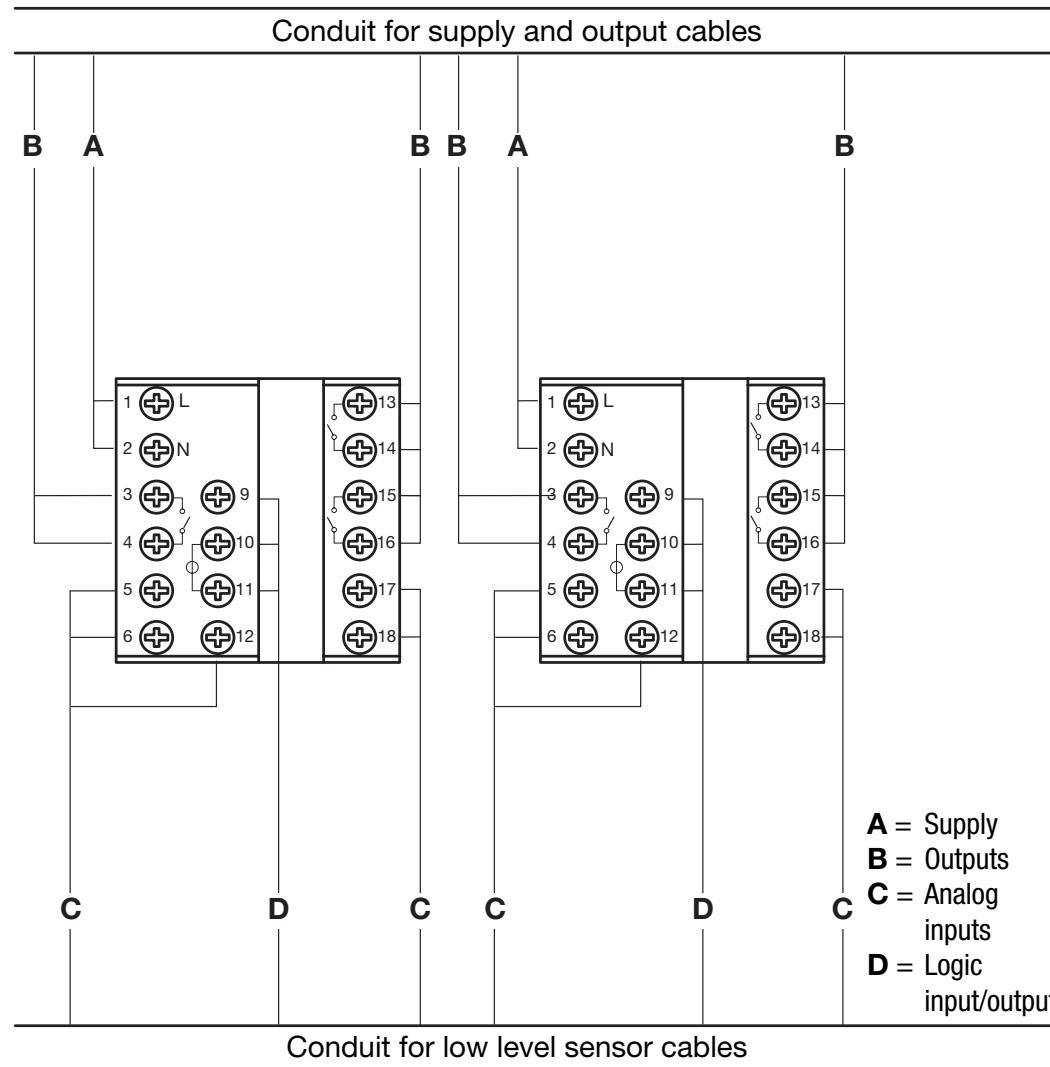
2.2 PRECAUTIONS AND ADVISED CONDUCTOR COURSE

2.3 EXAMPLE OF WIRING DIAGRAM (HEAT COOL CONTROL)

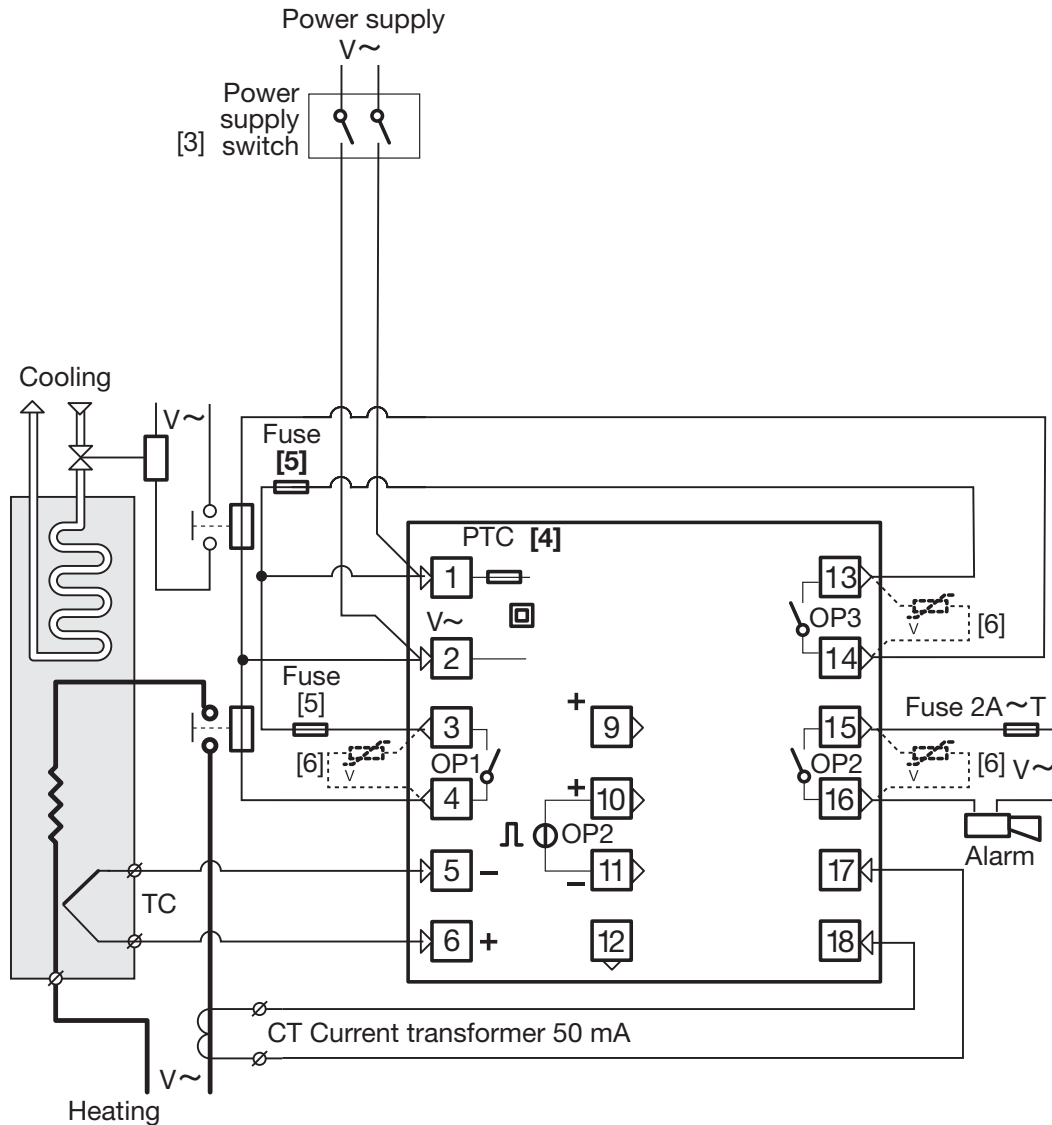

Notes:

- 1] Make sure that the power supply voltage is the same indicated on the instrument.
 - 2] Switch on the power supply only after that all the electrical connections have been completed.
 - 3] In accordance with the safety regulations, the power supply switch shall bring the identification of the relevant instrument. The power supply switch shall be easily accessible from the operator.
 - 4] The instrument is PTC protected. In case of failure it is suggested to return the instrument to the manufacturer for repair.
 - 5] To protect the instrument internal circuits use:
 - 2 A ~ T fuses for Relay outputs
 - 6] Relay contacts are already protected with varistors.
- Only in case of 24 V ~ inductive loads, use model A51-065-30D7 varistors (on request)**

2.3.1 POWER SUPPLY

Switching power supply with multiple isolation and internal PTC

- Standard version:
nominal voltage:
100 - 240V \sim (- 15% + 10%)
Frequency 50/60Hz
- Low Voltage version:
Nominal voltage:
24V \sim (- 25% + 12%)
Frequency 50/60Hz
or 24V- (- 15% + 25%)
- Power consumption 3VA max

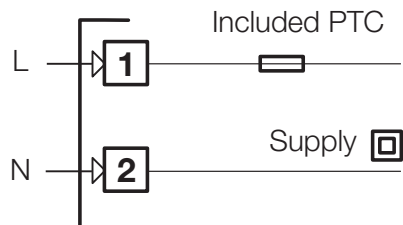
**2.3.2 PV CONTROL INPUT****A For L-J-K-S-T thermocouple type**

- Connect the wires with the polarity as shown
- Use always compensation cable of the correct type for the thermocouple used
- The shield, if present, must be connected to a proper earth.

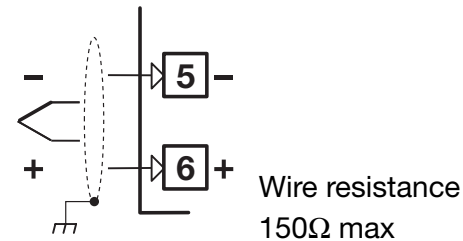
**B For Pt100 resistance thermometer**

- If a 3 wires system is used, use always cables of the same diameter (1mm² min.) (line 20 Ω/lead maximum resistance)
- When using a 2 wires system, use always cables of the same diameter (1,5mm² min.) and put a jumper between terminals 5 and 6

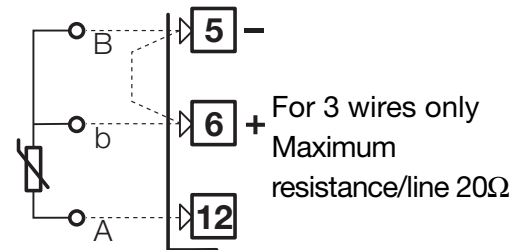
**C For ΔT (2x RTD Pt100) Special**

- ⚠ When the distance between the controller and the sensor is 15 mt. using a cable of 1.5 mm² diameter, produces an error on the measure of 1°C (1°F).

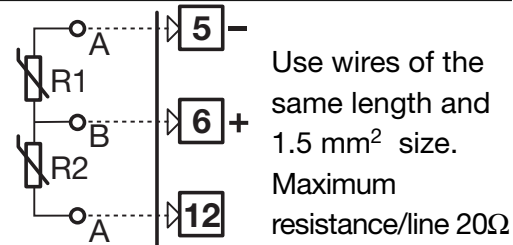

R1 + R2 must be <320Ω

2.3.2 PV CONTROL INPUT



D For mA, mV

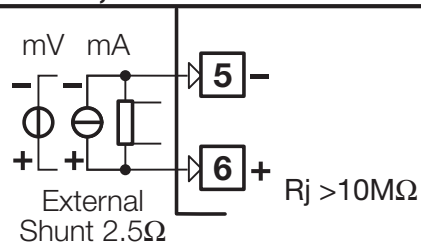

2.3.3 AUXILIARY INPUT

(option)



For current transformer CT

Not isolated

For the measure of the load current (see page 34)

- Primary coil 10A...100A
- Secondary coil 50mA default
100mA jumper selectable

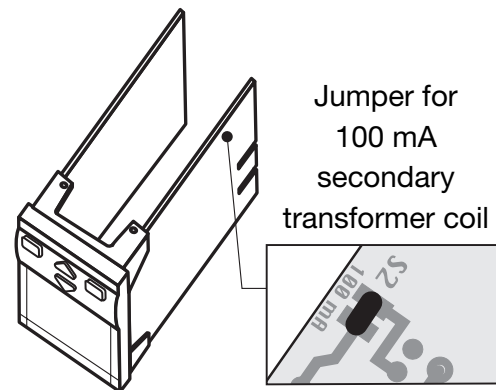
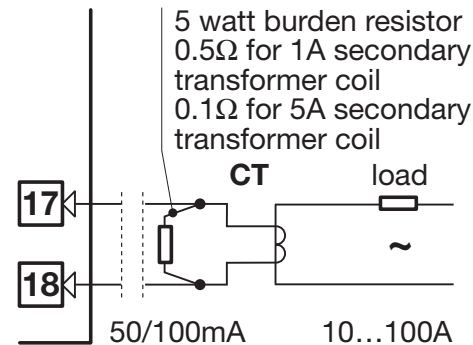

2.3.4 DIGITAL INPUT

(option) (page 35)



- The input is active when the logic state is ON, corresponding to the contact closed
- The input is inactive when the logic state is OFF, corresponding to the contact open

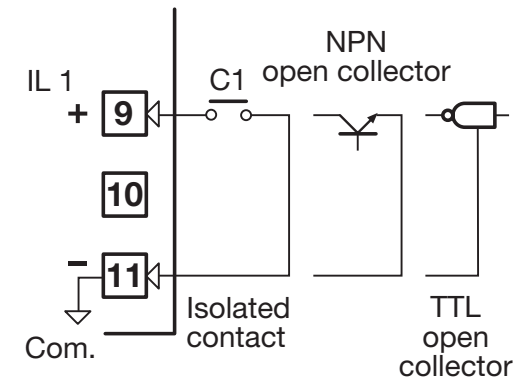

- To use with APG2-DRSPC board, see page 40.

2.3.5 OP1 - OP2 - OP3 OUTPUTS



The functionality associated to each of the OP1, OP2 and OP3 input is defined during the configuration of the instrument index **L** (see page 18).

The suggested combinations are:

	Control outputs			Alarms	
				AL2	AL3
A	Single action	OP1 Heat		OP2-R	OP3
B	Single action	OP2-L Heat		OP1	OP3
C	Double action	OP1 Heat	OP3 Cool	OP2-R [1]	
D	Double action	OP1 Heat	OP2-L Cool		OP3 [1]
E	Double action	OP2-L Heat	OP3 Cool	OP1 [1]	

OP1 - OP3	Relay output
OP2 - L	Logic output
OP2 - R	Relay output

Note

[1] With heat / cool control AL2 and AL3 share in or mode the same output (the free one).

OP2 output can be Relay (Std) or logic (option).

The “jumper” on the auxiliary board selects the output type:

Link Pins 1-2 for OP2-Relay

Link Pins 2-3 for OP2-Logic

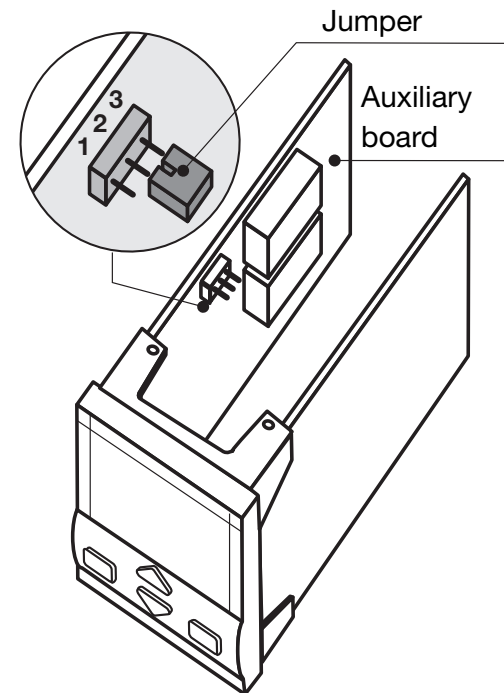

2.3.5-A SINGLE ACTION

RELAY (TRIAC)

CONTROL OUTPUT

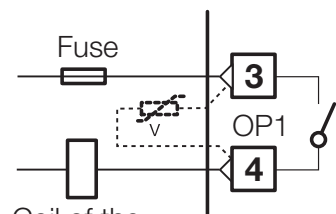

Coil of the heat load contactor

**Varistor for inductive load
24V~ only**

2.3.5-B SINGLE ACTION

LOGIC CONTROL

OUTPUT

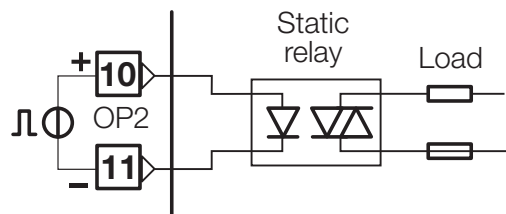

Relay output

- SPST Relay N.O., 2A/250 V~ for resistive load, fuse 2A ~ T

Logic output not isolated

- 0...5V-, ±20%, 30 mA max

2.3.5-C DOUBLE ACTION

RELAY/RELAY CONTROL OUTPUT

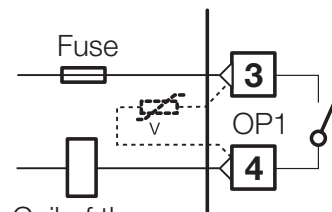

Coil of the heat load contactor

**Varistor for inductive load
24V~ only**

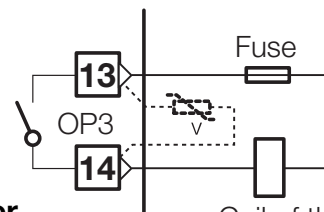

Coil of the cool load contactor

2.3.5-D DOUBLE ACTION

RELAY/LOGIC CONTROL OUTPUT

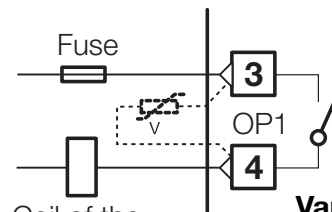

Coil of the heat load contactor

**Varistor for inductive load
24V~ only**

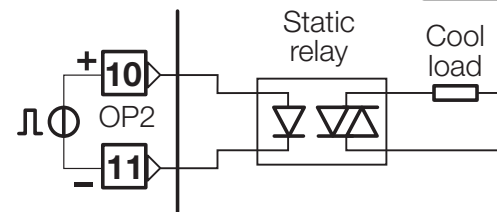

2.3.5-E DOUBLE ACTION

LOGIC/RELAY CONTROL OUTPUT

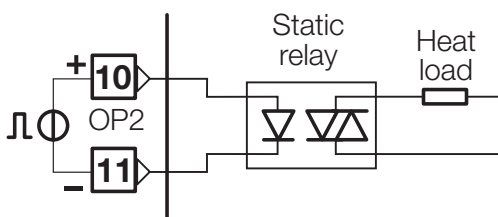

**Varistor for inductive load
24V~ only**

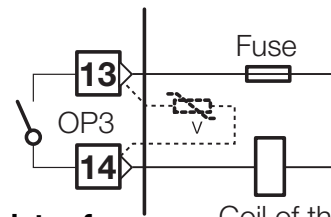

Coil of the cool load contactor

2.3.6 ALARMS OUTPUTS

 The outputs **OP1**, **OP2** (Relay optional) and **OP3**, can be used as alarm outputs only if they are not configured as control outputs.

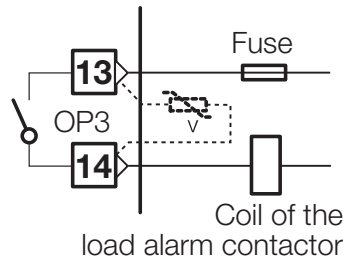
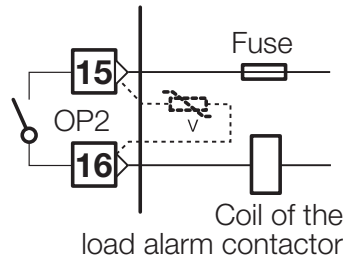
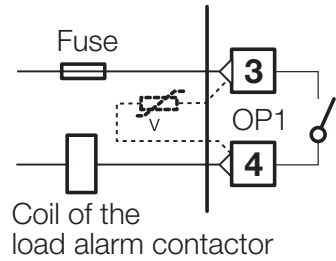

Varistor for inductive load
24V~ only

3

PRODUCT CODING

The complete code is shown on the instrument label. The informations about product coding are accessible from the front panel by mean of a particular procedure described at section 4.2.2 page 21

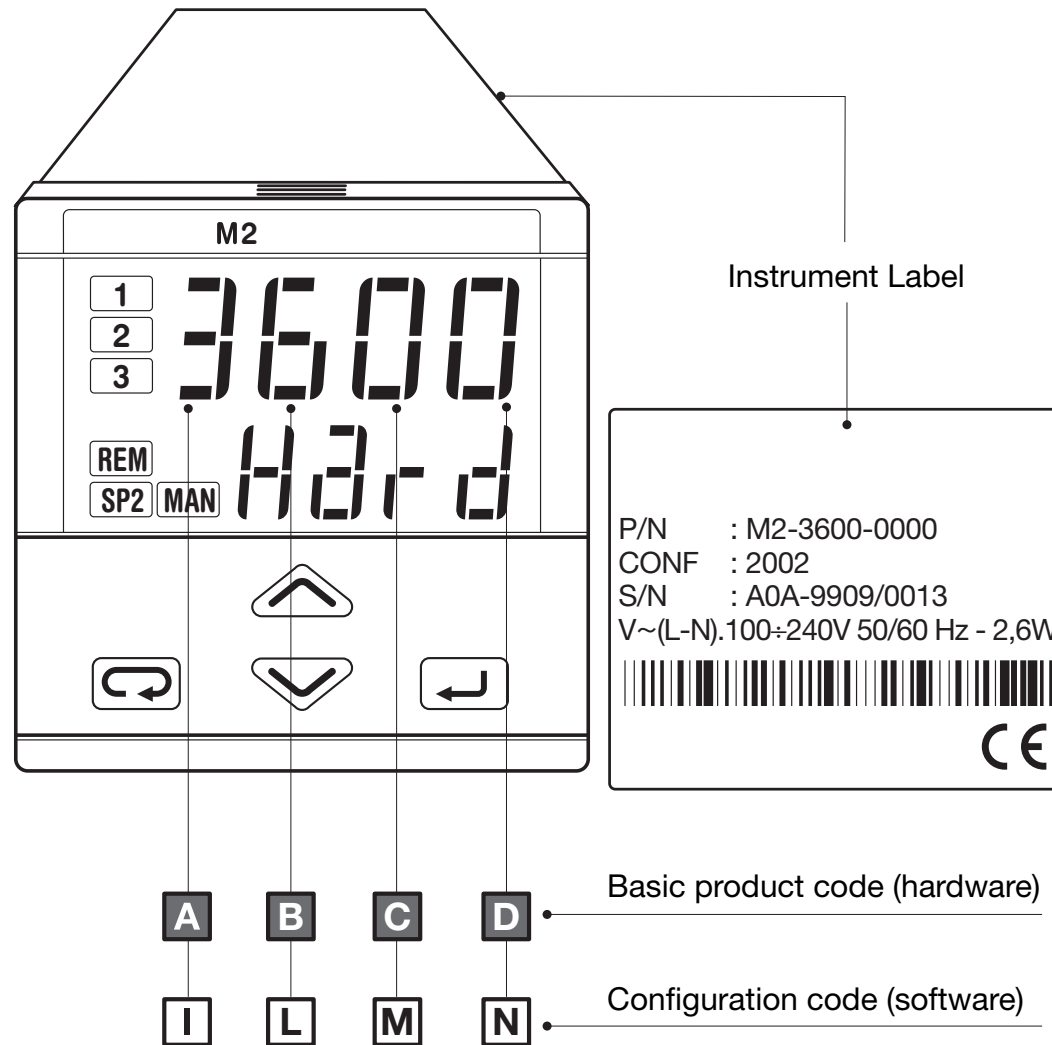

3.1 MODEL CODE

The product code indicates the specific hardware configuration of the instrument, that can be modified, by specialized engineers only.

Model: **Line** **M 2** **Basic** **A B C D** - **Accessories** **E F G 0** / **Configur.** **I L M N**

Line	M 2
-------------	------------

Power supply	A
100 - 240V~ (- 15% + 10%)	3
24V~ (- 25% + 12%) or 24V- (- 15% + 25%)	5

OP2 Outputs	B
Relay and Logic	1
Only Logic	6

Digital input	Options	C	D
Not fitted	None	0	0
	Current transformer input (CT) [1]	0	3
Fitted	None	9	0
	CT [1]	9	3

Special functions	E
Not fitted	0
SP Raise/Lower by digital input	6
Safety average OP on sensor break	7
Digital remote setpoint control + Safety average OP on sensor break	8

[1] Only for B=1

User manual	F
Italian/English (std)	0
French/English	1
German/English	2
Spanish/English	3

Front panel colour	G
Dark (std)	0
Beige	1

3.2 CONFIGURATION CODING

The configuration code consists of 4 digits that identify the operating characteristic of the controller, as chosen by the user.

Section 4.6 at page 35 reports the instructions how to set a new configuration code.

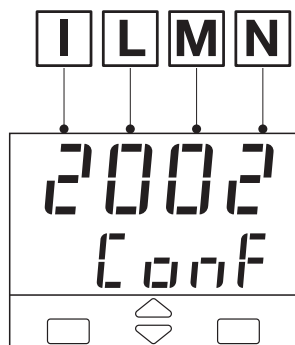

The configuration code can be displayed on the front panel, following the instructions at page 21 section 4.2.2.

Input type and range			I
TR Pt100 IEC751	-99.9...300.0 °C	-99.9...572.0 °F	0
TR Pt100 IEC751	-200...600 °C	-328...1112 °F	1
TC L Fe-Const DIN43710	0...600 °C	32...1112 °F	2
TC J Fe-Cu45% Ni IEC584	0...600 °C	32...1112 °F	3
TC T Cu-CuNi	-200 ...400 °C	-328...752 °F	4
TC K Cromel -Alumel IEC584	0...1200 °C	32...2192 °F	5
TC S Pt10%Rh-Pt IEC584	0...1600 °C	32...2912 °F	6
DC input 0...50 mV, linear	Engineering units		7
DC input 10...50 mV, linear	Engineering units		8
Custom input and range	[1]		9

[1] For instance, other thermocouples types, ΔT (with 2 PT 100), custom linearisation etc.

Control mode	Output configuration [1]	L
PID	Control OP1 / alarm AL2 on OP2	0
	Control OP2 / alarm AL2 on OP1	1
On - Off	Control OP1 / alarm AL2 on OP2	2
	Control OP2 / alarm AL2 on OP1	3
Heat/Cool action	Control OP1- OP3 / alarm AL2 on OP2	6
	Control OP1- OP2 / alarm AL2 on OP3	7
	Control OP2- OP3 / alarm AL2 on OP1	8

Control action type		M
Reverse (single action)	Linear Cool (Heat/Cool double action)	0
Direct (single action)	On-Off Cool (Heat/Cool double action)	1



If, when the controller is powered up for the first time, the display shows the following message

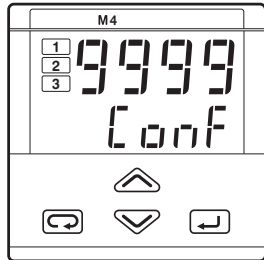

it means that the controller has not been configured yet.

The controller remain in stand-by until the configuration code is set correctly (see chapter 4.6 page 35).

Alarm 2 type and function		N
Disabled		0
Sensor break alarm / Loop Break Alarm		1
Absolute	active high	2
	active low	3
Deviation	active high	4
	active low	5
Band	active out	6
	active in	7
Heater break by CT [2]	active during ON output state	8
	active during OFF output state	9

Alarm 3 type and function		O
Disabled		0
Sensor break alarm / Loop Break Alarm		1
Absolute	active high	2
	active low	3
Deviation	active high	4
	active low	5
Band	active out	6
	active in	7
Heater break by CT [2]	active during ON output state	8
	active during OFF output state	9

For alarm 3 type and function see page 34

Note

[2] Only with CT options.

4 OPERATIONS

4.1.A KEYS FUNCTIONS AND DISPLAY IN OPERATOR MODE

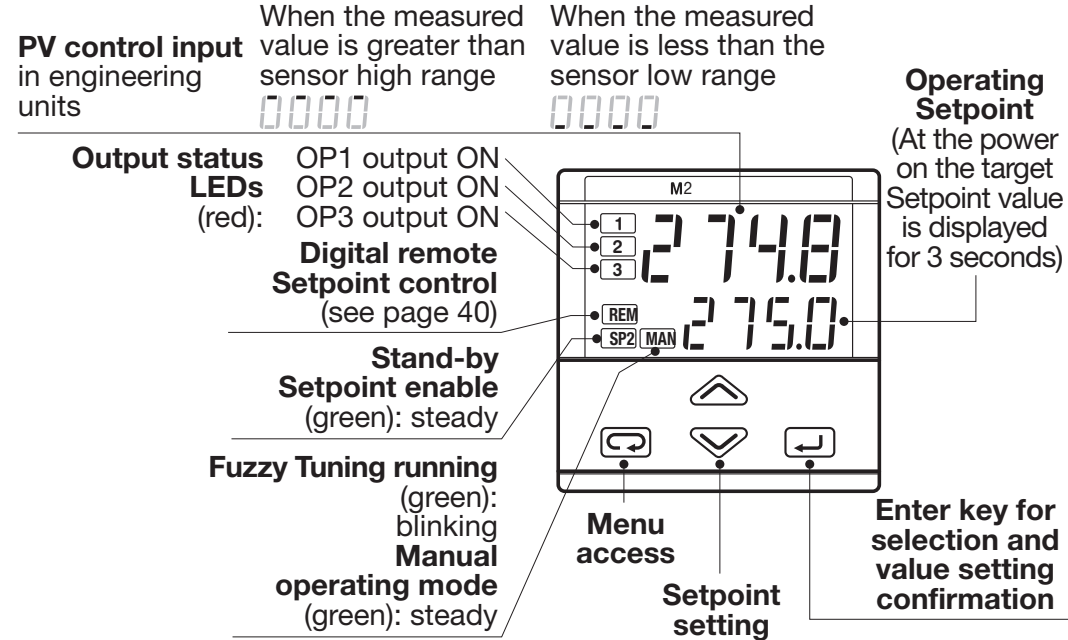

4.1.B KEYS FUNCTIONS AND DISPLAY IN PROGRAMMING MODE

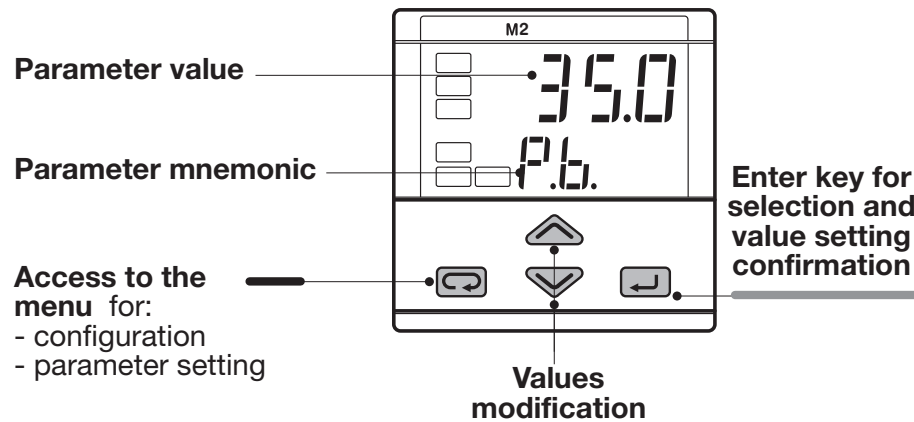

4.2 DISPLAY

During the operation, the parameters values cannot be modified by the user

4.2.1 OF THE PROCESS VARIABLES

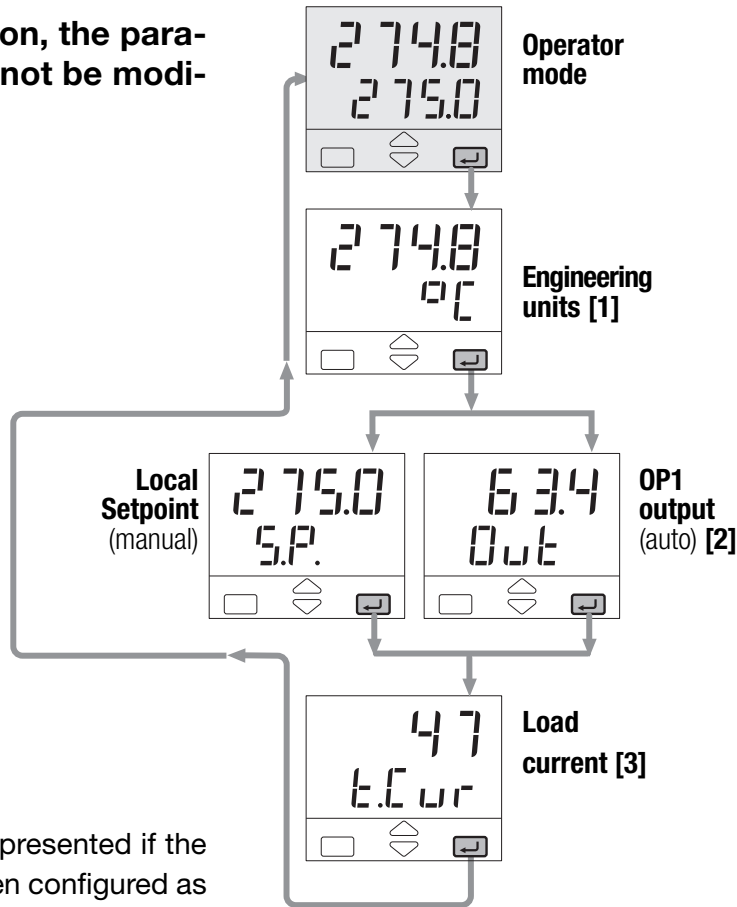

Note

- [1] See table page 37
- [2] This display is not presented if the instrument has been configured as an On - Off controller
- [3] Value in Ampere. Only with CT option (see page 34)

4.2.2 OF THE CONFIGURATION CODES

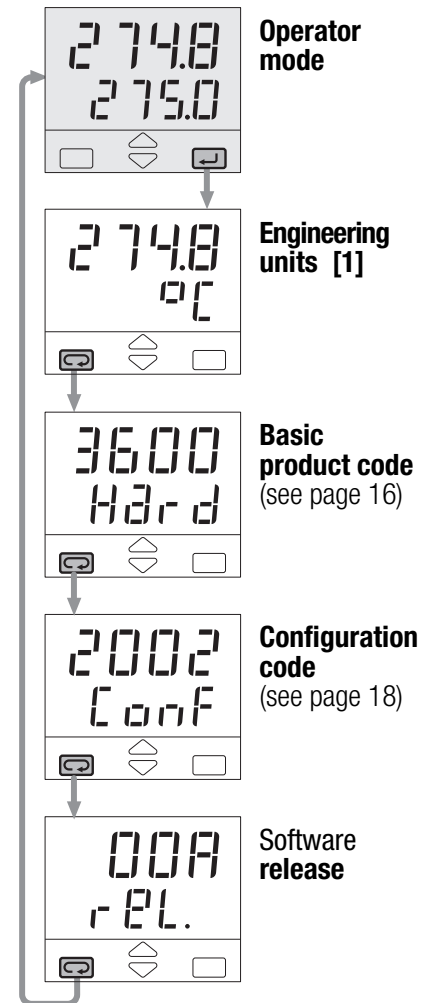





Example:
M2 - 3600 - 2002 / Release 00A

4.3 PARAMETER SETTING

4.3.1 NUMERIC ENTRY

(i.e. the modification of the Setpoint value from 275.0 to 240.0)

Press  or  momentarily to change the value of 1 unit every push

Continued pressing of  or  changes the value, at rate that doubles every second. Releasing the button the rate of change decreases.

In any case the change of the value stops when it has reached the max/min limit set for the parameter.



In case of Setpoint modification: press  or  once to display the local Setpoint instead of working Setpoint.

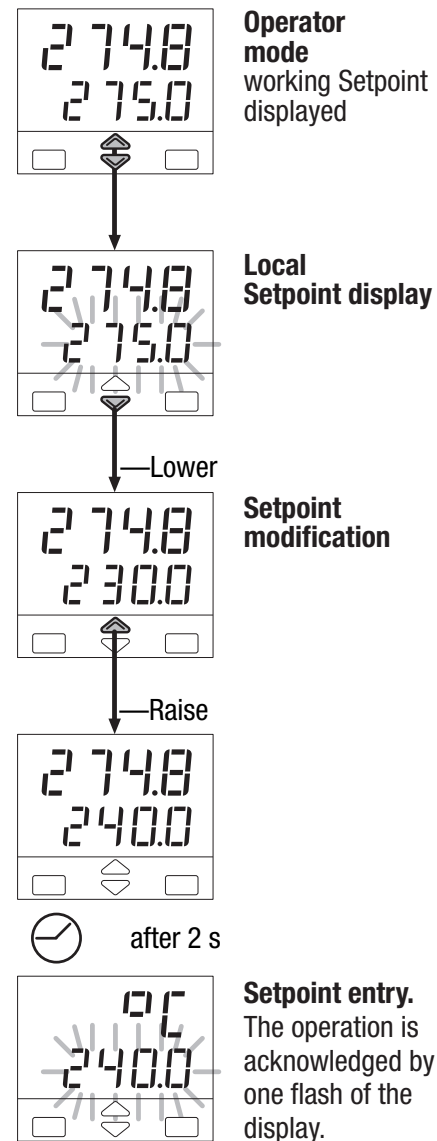

To evidence this change the display flashes once. Then the Setpoint can be modified



4.3.2 MNEMONIC CODES SETTING



(e.g. configuration see page 35)

Press the  or  to display the next or previous mnemonic for the selected parameter.

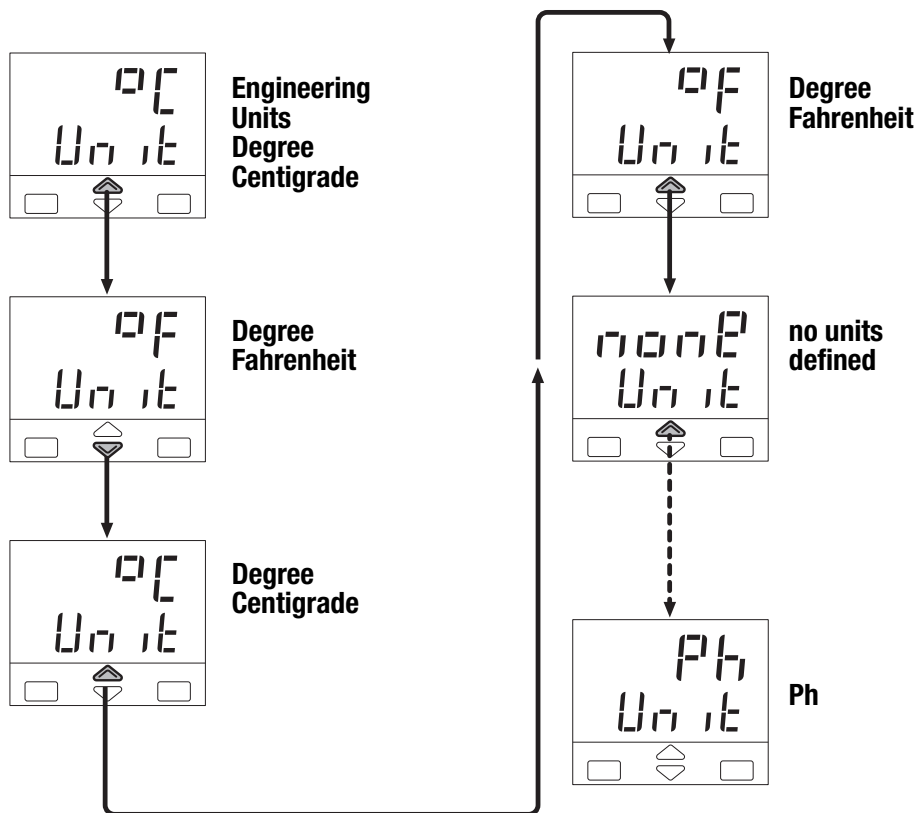
Continued pressing of  or  will display further mnemonics at a rate of one mnemonic every 0.5 s. The mnemonic displayed at the time the next parameter is selected, is the one stored in the parameter.



4.3.3 KEYPAD LOCK

To lock/unlock the keypad press the keys  and  simultaneously for 2 seconds.

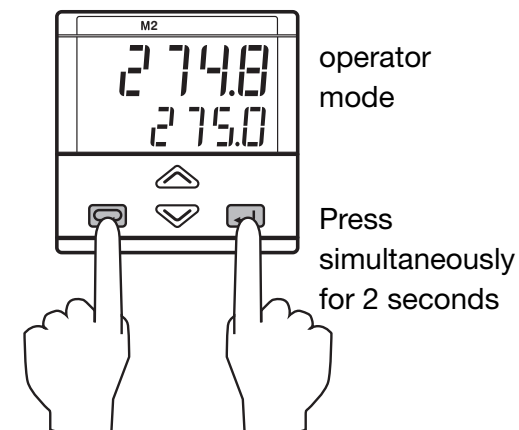

To confirm the keypad lock/unlock the display flashes once.



The keypad lock/unlock can be achieved by serial communications too.

 The keypad lock is maintained in case of power failure.

4.3.4 OUTPUTS LOCK

The outputs are switched to the OFF status by pressing the keys  and  together.

When the outputs are locked, the message **OFF** is displayed instead of the Setpoint value.

To unlock the outputs press again the keys simultaneously (the Soft-start will be enabled).

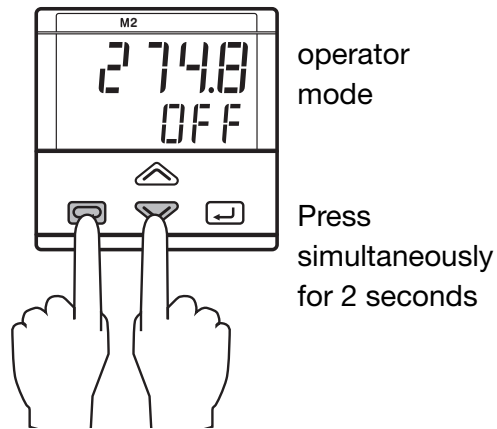





The outputs lock/unlock can be achieved by serial communications too

⚠ The outputs lock/unlock is maintained in case of power failure.

4.3.5 DIGITAL REMOTE SETPOINT CONTROL

(code E=6 or 8, see pag. 17)

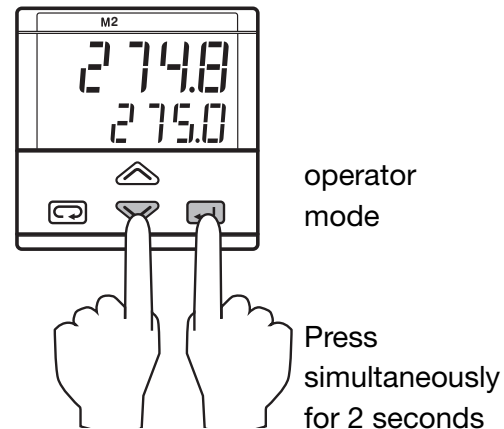

Holding pressed simultaneously for two second the  and  keys the Setpoint raise/lower function comes inhibited to indefinite time. The return to the full functionality is possible still pressing simultaneously for two second the  and  keys.

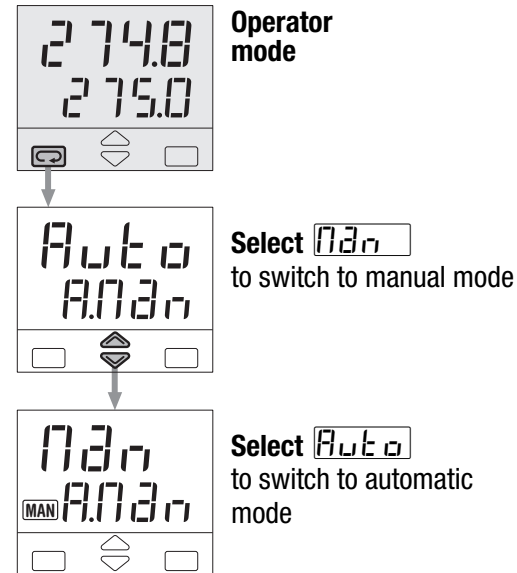

⚠ The raise/lower function lock is maintained in case of power failure

4.3.5 AUTO / MAN



- Press  to confirm. Back to operator mode.
- The **MAN** led shows the manual mode status.
- When manual mode is active, the Setpoint display shows the output value, that can be modified by  

4.4 PARAMETERISATION

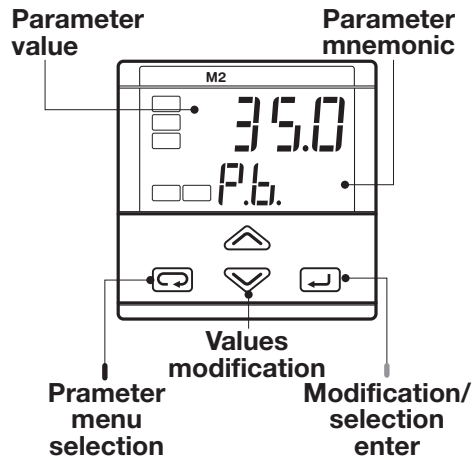

The parameter setting procedure has a timeout. If no keys are pressed for, at least, 30 seconds, the controller switches back, automatically, to the operator mode.

After having selected the parameter or the code, press and to display or modify the value (see page 22) The value is entered when the next parameter is selected, by pressing the key.

Pressing the key, the next group of parameters is presented on the display.

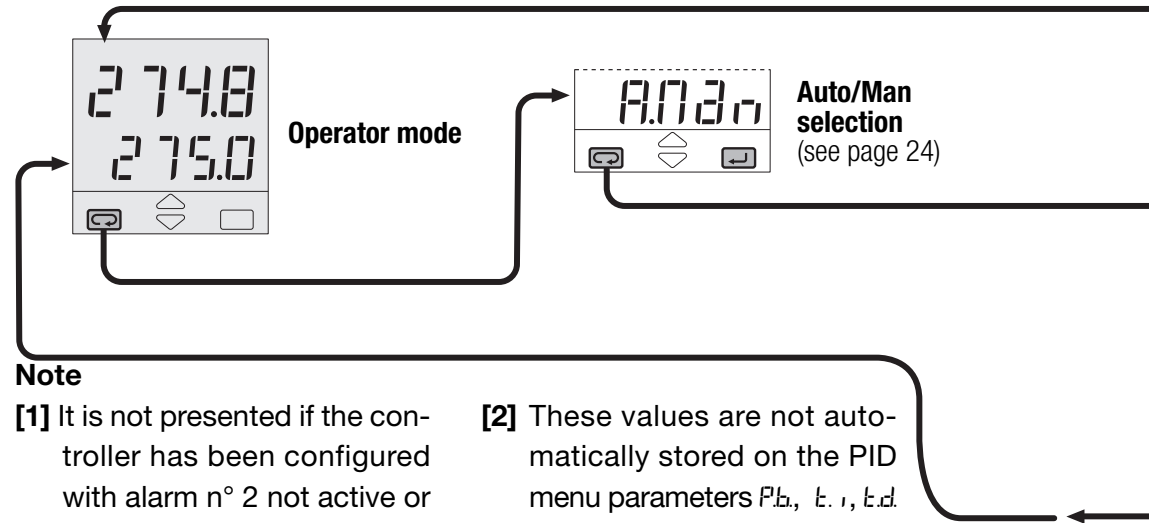

Note

[1] It is not presented if the controller has been configured with alarm n° 2 not active or of sensor break type. Digit N/M of the configuration code is assigned to 0 or 1.

[2] These values are not automatically stored on the PID menu parameters *P.b.*, *t.i.*, *t.d.*

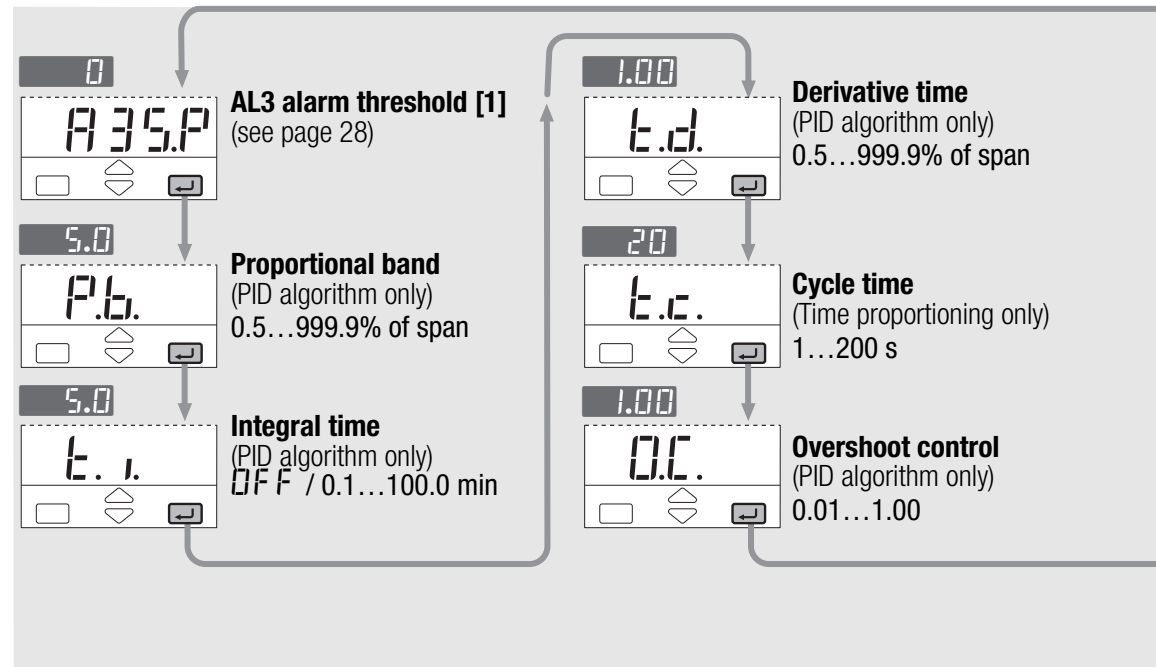

PARAMETER MENU

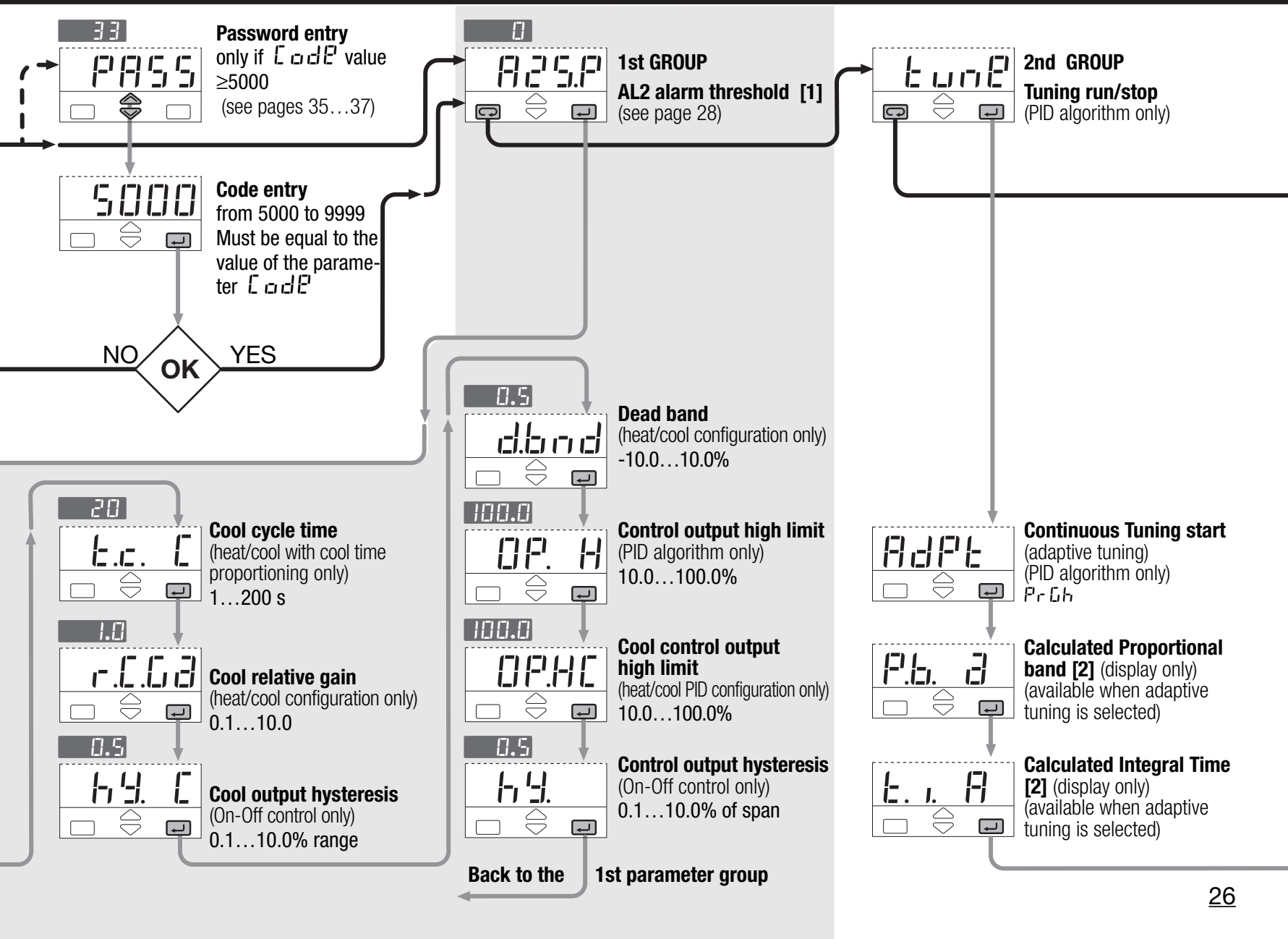

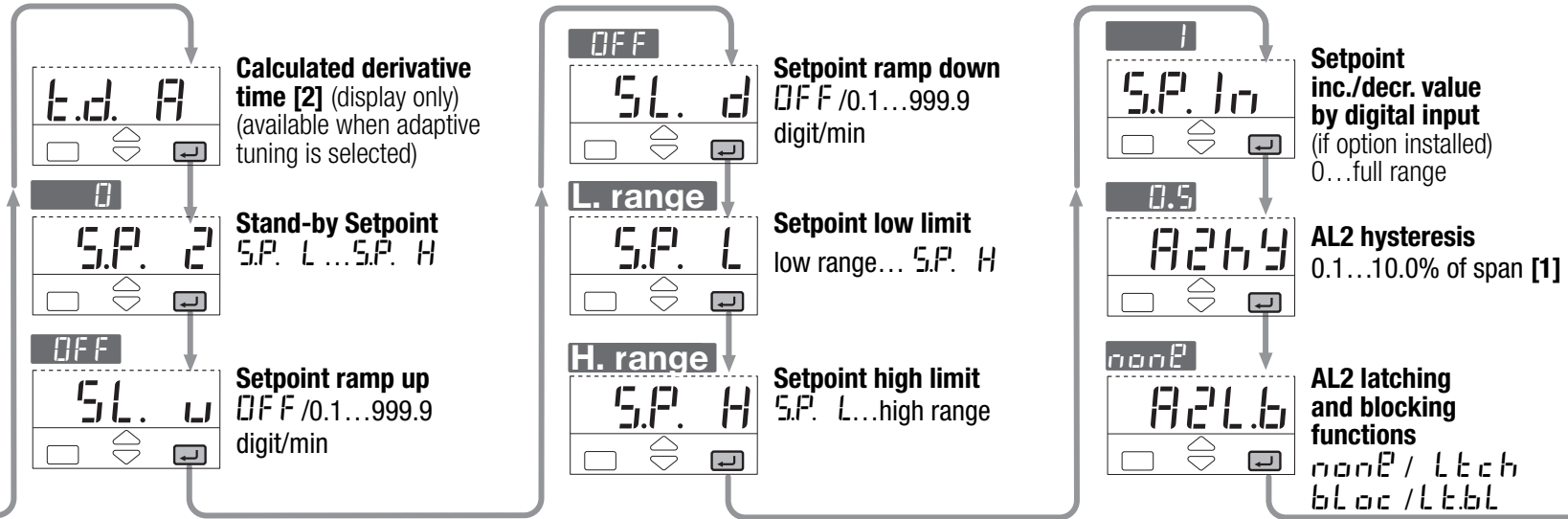



Password entry
only if *Code* value
<5000 (see pages 35...37)

Direct access
to the configuration
(pages 35 ... 37)



AL3 hysteresis
0.1...10.0% of span [1]

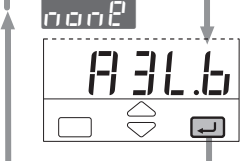

AL3 latching and blocking functions
none / *Ltch*
blac / *Ltbt*

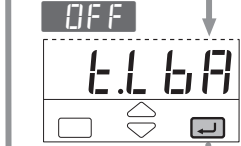

LBA delay
(see page 31)
OFF = sensor break
1...9999 s LBA

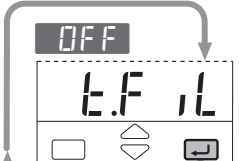

Filter time constant
1...30 s or *OFF*

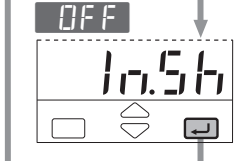

Input shift
-60...60 digits

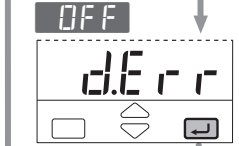

Error dead band
(PID algorithm only)
OFF / 0.1...10.0 digits



Soft-start output value
(PID algorithm and
OFF / 0.1...100.0%

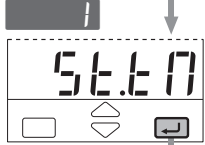

Soft-start activation time
(only if *St.OP* different than
OFF) 1...9999 s

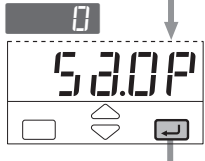

Output safety value
0.0...100.0%
(not shown if E = 7 or E = 8
see page 17)
(-100.0...100.0% for
heat/cool)

Back to the 2nd parameter group

4.5 PARAMETERS

FIRST GROUP

The controller parameters have been organised in group, according to their functionality area.

A25.P AL2 alarm threshold
A35.P AL3 alarm threshold

The alarm occurrences handle the OP1, OP2 and OP3 outputs, in different ways, according to the configured types of alarms, as illustrated.

With double action control output, AL2 and AL3 share in or mode the same output (the free one) (see table on page 13)

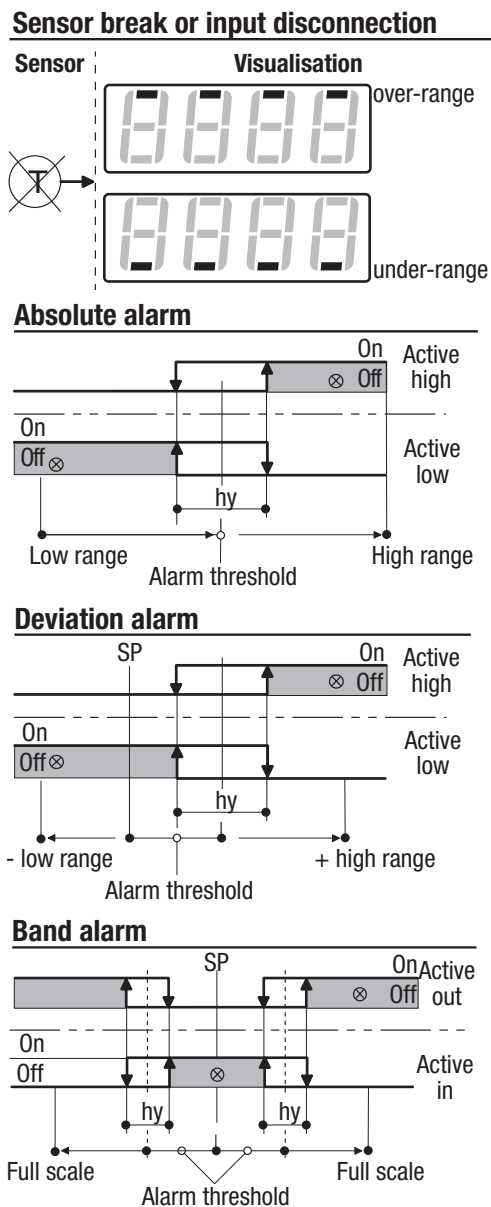

P.b. Proportional band

This parameter specifies the proportional band coefficient that multiplies the error (SP - PV)

I. I. Integral time

It is the integral time value, that specifies the time required by the integral term to generate an output equivalent to the proportional term. When **OFF** the integral term is not included in the control algorithm.

t.d. Derivative time

It is the time required by the proportional term P to repeat the output provided by the derivative term D. When **OFF** the derivative term is not included in the control algorithm.

t.c. Control output cycle time

t.c. Cycle time cool

It's the cycle time of the logic control output. The PID time proportional control output is provided through the pulse width modulation of the digital waveform.

OC.**Overshoot control**

(Automatically disabled when the adaptive tuning is running).

This parameter specifies the span of action of the overshoot control. Setting lower values (0.99 → 0.01) the overshoot generated by a Setpoint change is reduced. The overshoot control doesn't affect the effectiveness of the PID algorithm. Setting 1, the overshoot control is disabled.

dbnd**Heat/Cool dead band**

This parameter specifies the width of the deadband between the Cool and the Heat channel.

OP.H**Control output high limit****OP.HC****Cool output high limit**

It specifies the maximum value the control output can be set

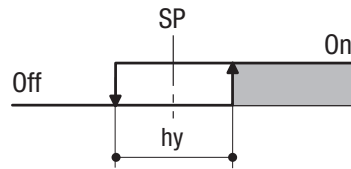
hy.**Control output hysteresis****hy.C****Cool output hysteresis****Hysteresis of the threshold**

Control or alarm output hysteresis span, set in % of the full scale.

SECOND GROUP**S.P. 2****Stand-by Setpoint****SL. u****Setpoint ramp up****SL. d****Setpoint ramp down**

This parameter specifies the maximum rate of change of the Setpoint in digit/min. When the parameter is *OFF*, this function is disabled.

S.P. L**Setpoint low limit****S.P. H****Setpoint high limit**

Low / high limit of the Setpoint value.

S.P. In**Setpoint increment/decrement step value by digital input****A2hy****AL2 alarm hysteresis****A3hy****AL3 alarm hysteresis**

Hysteresis of the threshold of both the alarms, that activate OP1 and OP2 control output. It is specified as a % of the full scale.

A2L.b**AL2, AL3 latching****A3L.b****and blocking functions**

For each alarm it is possible to select the following functions

none none*latch* latching*block* blocking*latch* both latching and blocking

ALARM

ACKNOWLEDGE FUNCTION

The alarm, once occurred, is presented on the display until to the time of acknowledge.

The acknowledge operation consists in pressing any key.

After this operation, the alarm leaves the alarm state only when the alarm condition is no longer present.

START-UP DISABLING

Ramp down

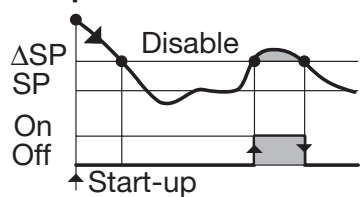

Ramp up

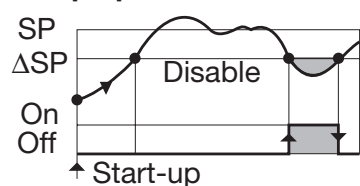

ΔSP Threshold = $SP \pm range$

ALARMS WITH LBA (LOOP BREAK ALARM) AND SENSOR BREAK OPERATION

Select the code 1 on **N** or **O** configuration indexes (see pages 18 or 19). The following parameter is then available:

LBA delay

Setting a value between 1 and 9999 s the alarm works as LBA+Sensor break with delay [1]

This condition is shown by means a red led as well as the blinking PV display.

Setting OFF the alarm works as Sensor break with immediate action.

This condition is shown by means the red led of the selected alarm as well as:

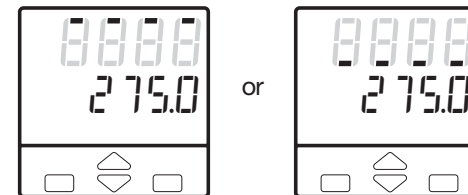
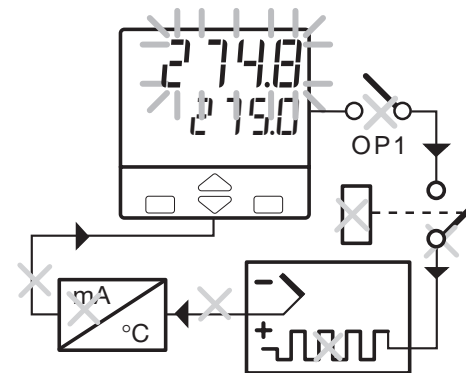

Note [1] In case of sensor break, condition, the alarm action is immediate.

When the cause of the alarm disappears, the alarm status stops.

SECOND GROUP**t.F tL****Input filter
time constant**

Time constant, in seconds, of the RC input filter applied to the PV input. When this parameter is set to **OFF** the filter is bypassed.

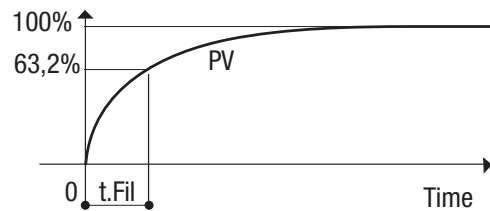
Filter response**1n.5h****Input shift**

This value is added to the measured PV input value. Its effect is to shift the whole PV scale of up to ± 60 digits.

d.E r r**Error Dead
Band**

Inside this band for (PV - SP), the control output does not change to protect the actuator (output Stand-by)

5E.OP**Soft-start
control output
value**

Value of the control output during the Soft-start activation time.

5E.E T**Soft-start
activation time**

Time duration (starting from the power on) of the Soft-start function.

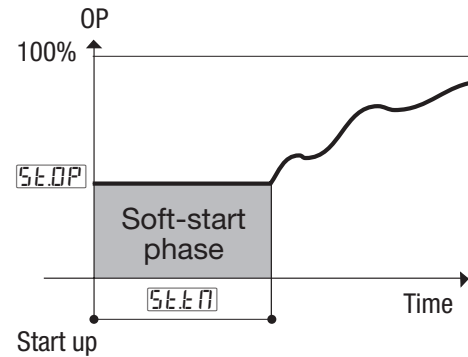
**5a.OP****Output
Safety Value**

Output Value in case of input anomaly
Not shown if E = 7 or E = 8 (see page 17)

HEAT COOL CONTROL

By a sole PID control algorithm, the controller handles two different outputs, one of these performs the Heat action, the other one the Cool action.

It is possible to overlap the outputs.

The dead band parameter `dbnd` is the zone where it is possible to separate or overlap the Heat and Cool actions.

The Cool action can be adjusted using the relative cool gain parameter `r.c.g.a`.

To limit the Heat and Cool outputs the parameters `OP.H` and `OP.HC` can be used.

When there is an overlap, the displayed output `OUT` shows the algebraic sum of the Heat and Cool outputs.

A Heat /Cool actions separated

Insert positive `dbnd` value (0...10%)

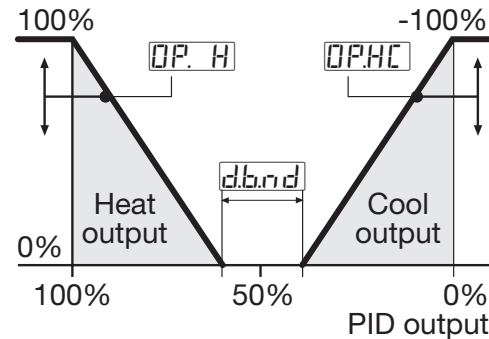

B Heat /Cool actions overlapped

Insert negative `dbnd` value (-10...0%)

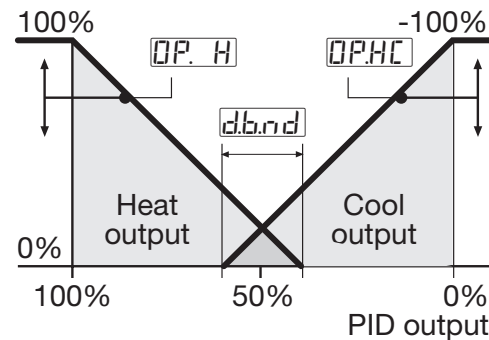

C Cool action adjusting

Example with different relative cool gains

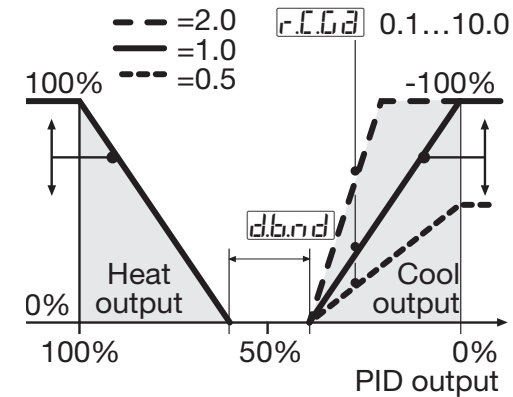

D On-Off Cool action

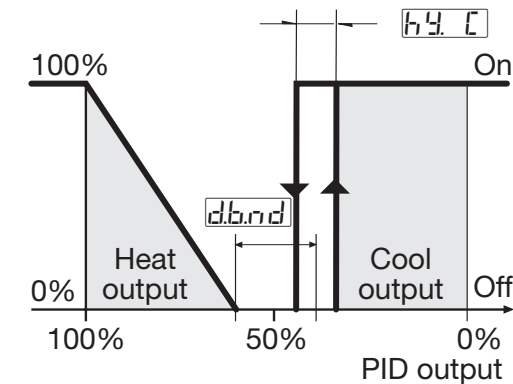

CURRENT TRANSFORMER INPUT

With CT option it is possible to display the load current and set an alarm threshold.

It is possible to set AL2 or AL3 (index 8 and 9) to have an alarm when, during the ON time of the time proportional output, the load current is less than the specified threshold or, during the OFF time, there is at least 3% of full scale

load current

The alarm condition must be longer than 120 ms to set the alarm.

During the OFF time the parameter t_{LUR} latches the last on time current value

Example:

CT input on OP1, alarm on AL2 during on time (configuration digit N = 8)

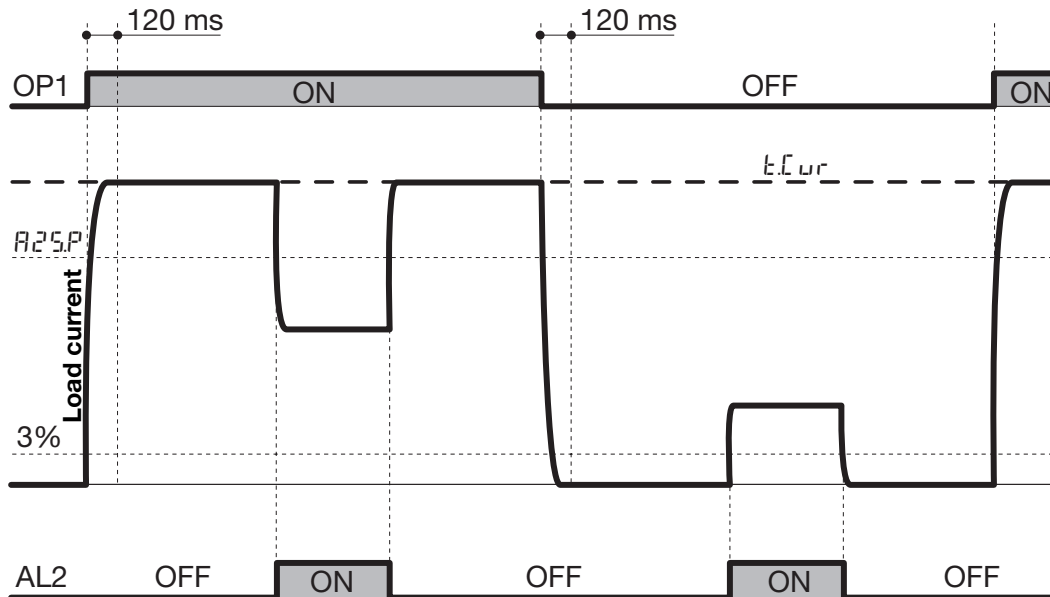

4.6 CONFIGURATION

The configuration of the controller is specified through a 4 digit code that defines the type of input, of control output and of the alarms. (sect. 3.2 page 18)

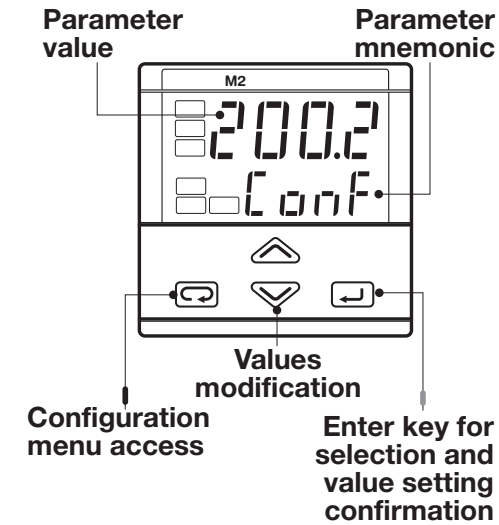

Press or to display the next parameter or the next code and change its value.

The new value entered is stored into the controller when the next parameter is selected by pressing .

Pressing the the next group of parameters is displayed.

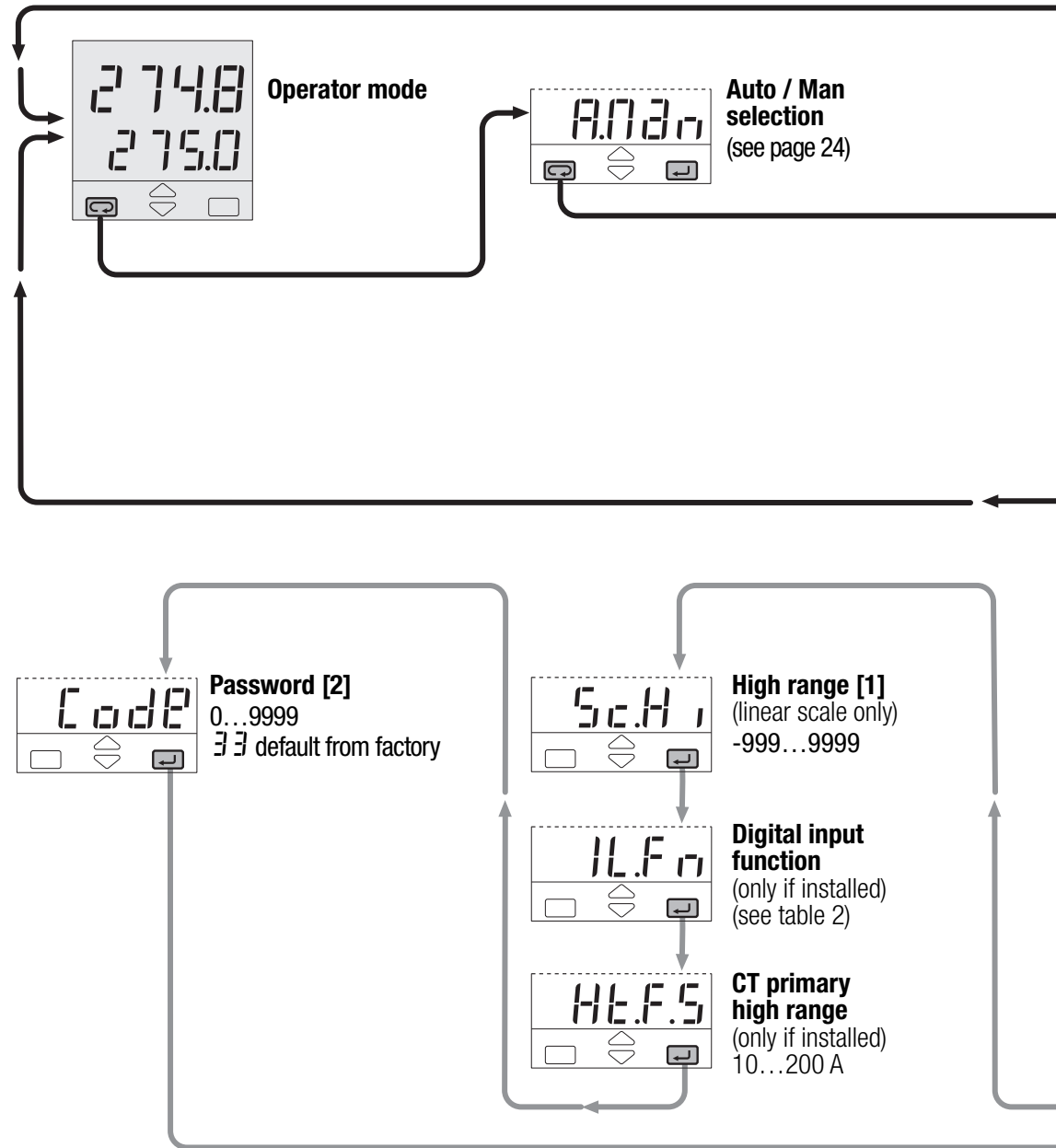

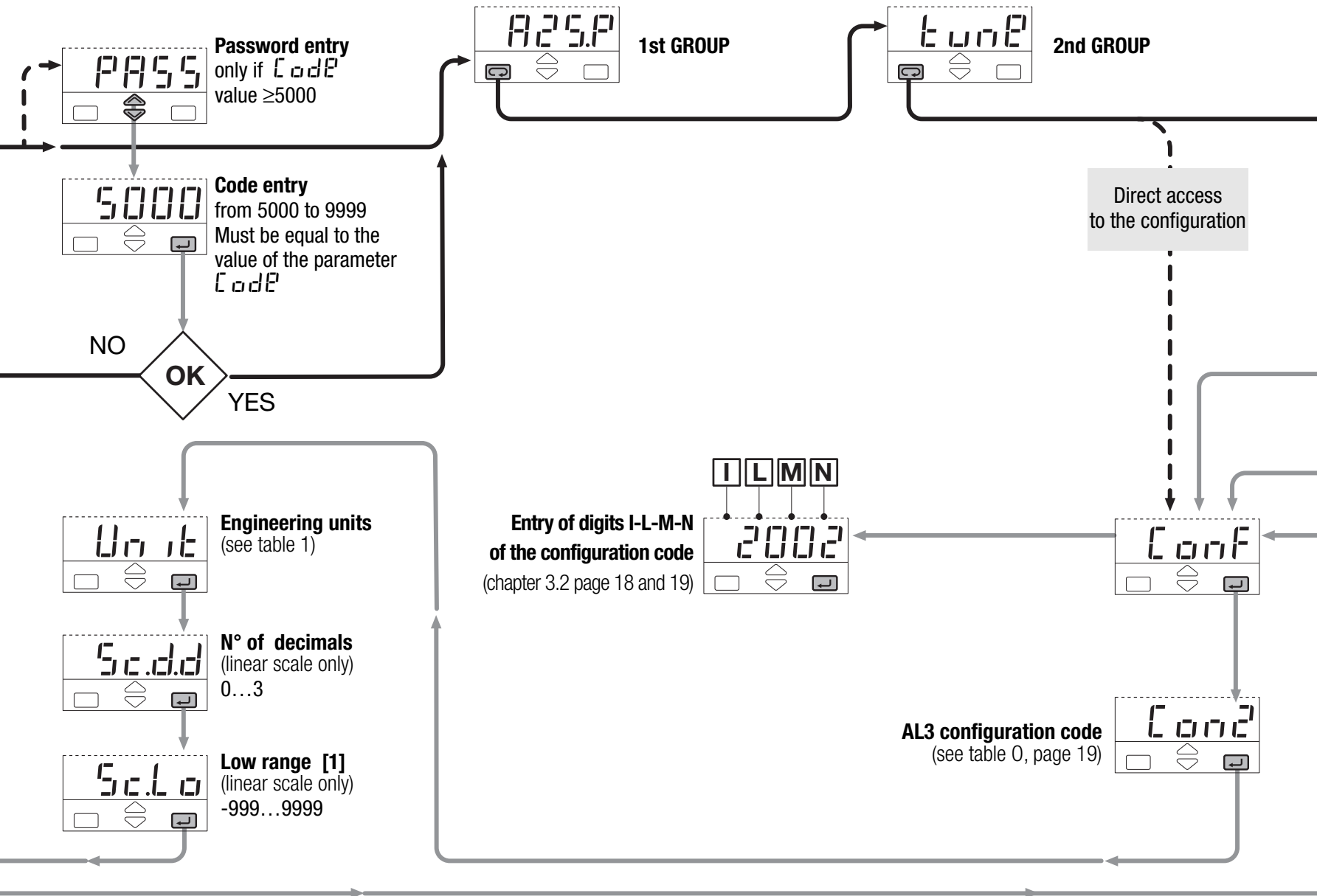

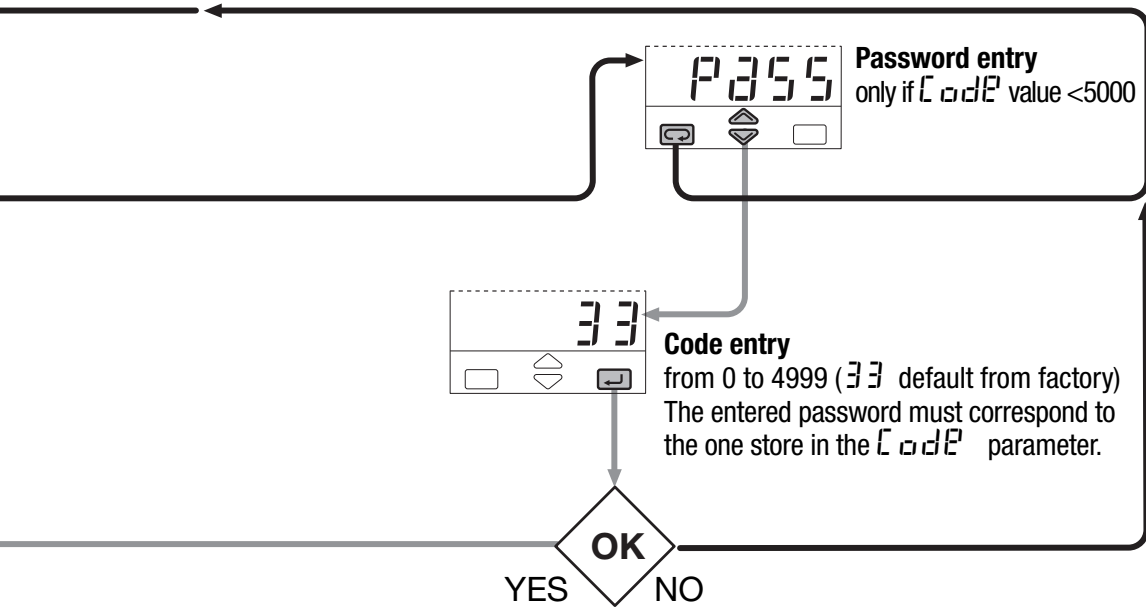

Table 1 - Supported Engineering Units.

Centigrade degrees*	°C
Fahrenheit degrees *	°F
none	none
mV	mV
Volt	V
mA	mA
Ampere	A
Bar	bar
PSI	PSI
Rh	rh
pH	pH

* For inputs from thermocouple or resistance thermometer, the choice is between °C and °F only.

Table 2- Digital input functions

Not used	OFF
Keypad lock	EEP.1
Auto/Man	AN.M
Stand-by Setpoint	S.P. 2
Remote Setpoint control [3]	cust

Notes

- [1] Minimum Range 100 digits.
- [2] **To avoid free parameter access insert 5000...9999**
- [3] If option installed

Direct access to the configuration

A From parameterisation (see page 27).

B At the first power on when the controller is not configured:

In this situation, the controller has its outputs and inputs not active.
This situation ends when a correct configuration code is entered.

5 ■ AUTOMATIC TUNING

Two tuning methods are provided:

- Initial one shot **Fuzzy-tuning**
- Continuous, self learning **Adaptive Tuning**

The Fuzzy-Tuning allows the calculation of the optimal PID terms parameters, monitoring the response of the process to disturbances.

The controller provides 2 types of “one shot” tuning algorithm, that are selected automatically according to the process condition when the operation is started.

Step response

This type is selected when, at the start of the autotune operation, the PV is far from the Setpoint of more than 5% of the span.

This method has the big advantage of fast calculation, with a reasonable accuracy in the term calculation.

Natural frequency

This type is selected when the PV is close to the SP Setpoint.

This method has the advantage of

a better accuracy in the term calculation with a reasonable speed calculation.

The Fuzzy Tuning determines automatically the best method to use to calculate the PID term, according the process conditions.

Step response

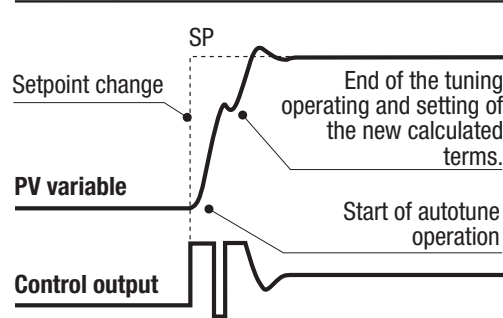

Natural frequency

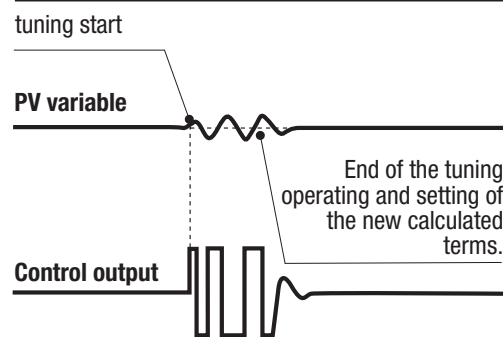

Operator mode



press until



To start select **Start**

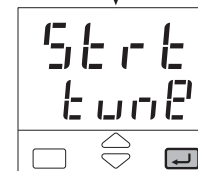

To stop select **Stop**

The green led **MAN** blinking goes on when the Fuzzy Tuning is in progress. At the end of this operation, the calculated PID terms parameter are stored and used by the control algorithm and the controller goes back to the operator mode. The green led **MAN** becomes off.

The self-learning **Adaptive Tuning** is not intrusive. It doesn't affect the process, at all, during the phase of calculation of the optimal terms parameters.

Continuous adaptive tune

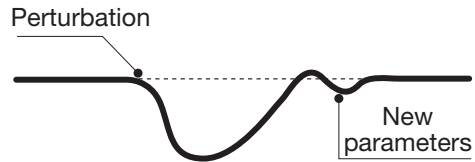

It is particularly suitable for controlling process whose control characteristics change with time or are not linear in relation to the Setpoint values.

It doesn't require any operation by the user. It is simple and works fine: it samples continuously the process response to the various perturbations, determining the frequency and the amplitude of the signals. On the basis of this data and their statistical values, stored in the instrument, it modifies automatically the PID term parameters. It is the ideal for all applications where it is required to change con-

tinuously the PID terms parameters, in order to adjust the PID to the changes of the process dynamic conditions.

In case of power off with the Adaptive Tuning enabled, the values of the PID terms parameters are lost. At the power on the Adaptive Tuning starts automatically and computes again the values of the PID terms parameters.

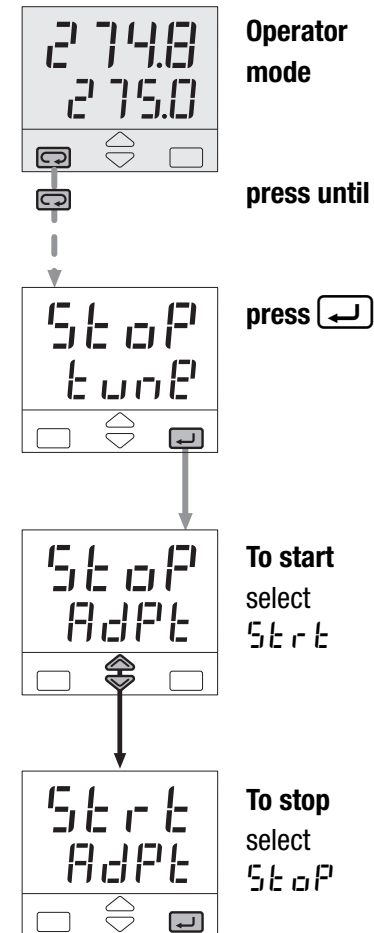

6 SPECIAL FUNCTIONS

Two special functions are available:

- 6.1 Safety average OP on sensor break**
- 6.2 Digital remote setpoint control** (Setpoint raise/lower + Stand-by Setpoint)

6.1 SAFETY STATE USING THE AVERAGE OF THE OUTPUT

This function is available only if the index E of the model code (see page 17) engages the value 7 or 8. The averages comes effected, filtering the output with a first order filter with around 50 seconds of constant of time. Such filter is active in a continuous way when the input is in conditions of normal operation; in conditions of out scale the refresh of the filter comes jammed and the reached value becomes the output.

The **S30P** parameter (see pages 28,32) doesn't appear when the option is enabled.

6.2 DIGITAL INPUT WITH REMOTE SETPOINT CONTROL

This function is available only if the index E of the product code of the model (see page 17) engages the value 6 or 8 and the digital input option (C index= 9) is present.

The parameter of configuration **ILFn** (see page 35) allows to set the **ILSt** value that enable the function.

Connecting to the digital input an output of the APG2- DRSPC card (see manual N. M.I.U. DRSPC J30-628-1ADRSPC) it is possible:

1. To increase the Setpoint of a step
2. To decrease the Setpoint of the same step
3. To select the Stand-by Setpoint **SP. 2** (see page 27)

The value of the step has given from the **SP. 1n** parameter (see pages 27,30).

When the option is activated the **REM** led comes alight and the function of the digital input it is the following:

Digital input disabled	The instrument operates on local Setpoint
Raise function activation	The local Setpoint increase of the value of <i>S.P. 1</i> , REM led flashes three times to point out the operation
Lower function activation	The local Setpoint decrease of the value of <i>S.P. 1</i> , the REM led flashes three times to point out the operation
Stand-by SP selection	The controller uses the Stand-by Setpoint <i>S.P. 2</i> , the SP2 led alight points out the state

7 TECHNICAL SPECIFICATIONS

Features (at 25°C environmental temp.)	Description			
Total configurability (see par. 3.2 page 18 par. 4.6 page 35)	From keypad the user selects: <ul style="list-style-type: none"> - the type of input - the type of control algorithm - the type and functionality of the alarms - the associated functions and the corresponding outputs - the type of output and the safe conditions - the values of all the control parameters. 			
PV Input (see page 11, 12 and page 18)	Common characteristics	A/D converter with resolution of 50,000 points Update measurement time: 0.2 seconds Sampling time: 0.5 seconds Input bias: - 60...+ 60 digit Input filter with enable/disable: 1...30 seconds		
	Accuracy	0.25% ± 1 digits for temperature sensors 0.1% ± 1 digits (for mV and mA)	Between 100...240V~ the error is minimal	
	Resistance thermometer (for ΔT: R1+R2 must be <320Ω)	Pt100Ω at 0°C (IEC 751) °C/°F selectable	2 or 3 wires connection Burnout (with any combination)	Max. wire Res: 20Ω max (3 wires) Sensitivity: 0.1°C/10° E. T. <0.1°C / 10Ω Wire Res.
	Thermocouple	L,J,T,K,S (IEC 584) Rj >10MΩ °C/°F selectable	Internal cold junction compensation con NTC Error 1°C/20°C ±0.5°C Burnout	Line: 150Ω max Input drift: <2μV/°C.Env. Temp <0.5μV / 10Ω Wire Res.
	DC input (current)	4...20mA, 0-20mA with external shunt 2.5Ω Rj >10MΩ	Engineering units Conf. decimal point position Init. Sc -999...9999 Full Sc. -999...9999	Input drift: <0.1% / 20°C Env. Temp.
	DC input (voltage)	10...50mV, 0-50mV Rj >10MΩ	(min. range of 100 digits)	

Features (at 25°C environmental temp.)	Description						
CT auxiliary input (option)	Current transformer (see page 12)	50 or 100 mA input hardware selectable	Current visualisation 10 ... 200A With 1A resolution and Heater Break Alarm				
Digital input (option)	The closure of the external contact produces any of the following actions: Auto/Man mode change, Stored Setpoint activation, Keypad lock, Remote Setpoint Control						
Operating mode and Outputs	1 double action PID loop or On/Off with 1 or 2 alarms	Single action	Control output		AL2 alarm	AL3 alarm	
			OP1-Relay	OP2-Logic or Relay(opt.)		OP3-Relay/Triac	
		Double action Heat/cool	OP2 -Logic		OP1-Relay	OP3-Relay/Triac	
			OP1-Relay	OP3-Relay	OP2-Logic or Relay(opt.)		
			OP1-Relay	OP2 Logic			OP3-Relay/Triac
			OP2 Logic	OP3-Relay	OP1-Relay		
Control mode	Algorithm		PID with overshoot control or On-Off				
	Proportional band (P)		0.5...999.9%				
	Integral time (I)		0.1...100.0 min	OFF = 0		PID algorithm	
	Derivative time (D)		0.01...10.00 min				
	Error band		0.1...10.0 digit				
	Cycle time		1...200 s				
	Dead band		-10.0...10.0%				
	Cool relative gain		0.1...10.0			Heat / cool control action	
	Cool cycle time		1...200 s				
	Overshoot control		0.01...1.00			PID algorithm	
	High limit		100.0...10.0% (heat) -100.0...-10.0%(cool)				
Hysteresis		0.1...10.0%			On-Off algorithm		

Features (at 25°C environmental temp.)	Description			
OP1 output	SPST Relay N.O., 2A/250V~ for resistive load			
OP2 output	Logic not isolated: 5V-, ± 10%, 30mA max SPST Relay(option), N.O., 2A/250V~ for resistive load	Jumper selectable (page 13)	Protection by varistor for 220V ~ and capacitor	
OP3 output	SPST Relay N.O., 2A/250V~ for resistive load,			
AL2 - AL3 alarms	Hysteresis 0.1...10.0% c.s.			
	Action	Active high	Action type	Deviation threshold ±range
		Active low		Band threshold 0...range
		Sensor break, heater break alarm, Latching/Blocking, Loop Break Alarm		Absolute threshold whole range
Setpoint	Local and stand-by, digital input or serial communications			
	Ramp up and down. User inhibited		0.1...999.9 digit/min	
	Low limit		from low range to high limit	
	High limit		from low limit to high range	
Tuning	Fuzzy-Tuning The controller selects automatically the best method according to the process conditions	Step response Natural frequency		
	Adaptive Tuning self-learning, not intrusive, analysis of the process response to perturbations and continuously calculation of the PID parameters			
Auto/Man station	Standard with bumpless function, by keypad, digital input or serial communications			

Features (at 25°C environmental temp.)	Description	
Operational safety	Measure input	Detection of out of range, short circuit or sensor break with automatic activation of the safety strategies and alerts on display
	Control output	Safety value: -100%...100% or Average (option)
	Parameters	Parameter and configuration data are stored in a non volatile memory for an unlimited time
	Access protection	Password to access the configuration and parameters data, keypad lock, output lock
General characteristics	Power supply (fuse protected)	100 - 240V~ (- 15% + 10%) 50/60 Hz or 24V~ (- 25% + 12%), 50/60 Hz and 24V- (- 15% + 25%) Power consumption 2.6W max
	Safety	Compliance to EN61010-1 (IEC 1010 – 1), installation class 2 (2500V) pollution class 2, instrument class II
	Electromagnetic compatibility	Compliance to the CE standards (see page 2)
	UL and cUL Omologation	File 176452
	Protection EN60529 (IEC 529)	IP65 front panel
	Dimensions	1/16 DIN - 48 x 48, depth 120 mm, weight 130 gr. apx.

■ WARRANTY

We warrant that the products will be free from defects in material and workmanship for 3 years from the date of delivery.

The warranty above shall not apply for any failure caused by the use of the product not in line with the instructions reported on this manual.

ASCON'S WORLDWIDE SALES NETWORK

SUBSIDIARY

FRANCE

ASCON FRANCE

Phone 0033 1 64 30 62 62

Fax 0033 1 64 30 84 98

AGENCE SUD-EST

Phone 0033 4 74 27 82 81

Fax 0033 4 74 27 81 71

AGENCE RÉGION-EST

Phone 0033 3 89 76 99 89

Fax 0033 3 89 76 87 03

DISTRIBUTORS

ARGENTINA

MEDITECNA S.R.L.

Phone +5411 4585 7005

Fax +5411 4585 3437

AUSTRALIA

IPA INDUSTRIAL PYROMETER

(AUST) PTY.LTD

Phone +61 8 8352 3688

Fax +61 8 8352 2873

FINLAND & ESTONIA

TIM-TOOL OY

Phone +358 50 501 2000

Fax +358 9 50 55 144

GERMANY

MESA INDUSTRIE ELEKTRONIK GMBH

Phone +49 2365 915 220

Fax +49 2365 915 225

GREECE

CONTROL SYSTEM

Phone +30 23 10 521 055-6

Fax +30 23 10 515 495

BRANCH OFFICE

Phone +30 1 646 6276

Fax +30 1 646 6862

HOLLAND

TEMPCONTROL I.E.P. B.V.

Phone +31 70 347 64 31

Fax +31 70 38 22 55 16

PORTUGAL

REGIQUIPAMENTOS LDA

Phone +351 21 989 0738

Fax +351 21 989 0739

SPAIN

INTERBIL S.L.

Phone +34 94 453 50 78

Fax +34 94 453 51 45

BRANCH OFFICES

Phone +34 93 311 98 11

Fax +34 93 311 93 65

Phone +34 91 656 04 71

Fax +34 91 656 04 71

SWITZERLAND

CONTROLTHERM GMBH

Phone +41 1 954 37 77

Fax +41 1 954 37 78

TURKEY

KONTROL SISTEMLERI LTD

Phone +90 216 527 96 15

Fax +90 216 527 96 20

UNITED KINGDOM

EUKERO CONTROLS LTD

Phone +44 20 8568 4664

Fax +44 20 8568 4115