

5 Digits Configurable Display Color Indicator 1/8 DIN - 96 x 48 mm gammadue® Series J1/J3 lines

Common features

- 5 Digits Green/Red configurable display
- Up to 2 inputs
- RS485 Modbus serial communications protocol
- 3 Digital inputs
- Up to 4 relay alarms with ISA A sequence
- Analogue retransmission
- Input 1 conditioned by input 2
- Different kinds of visualization
- Peak/Valley functions
- Alarm acknowledge dedicated key

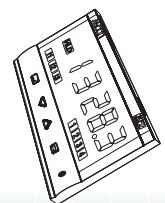
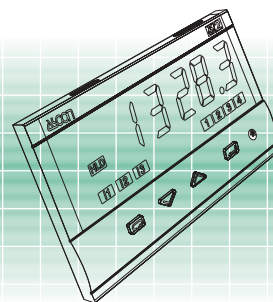
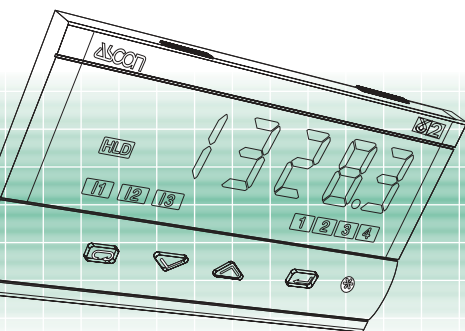

E

ISO 9001 Certified

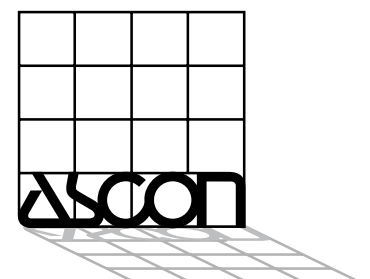



gammadue®

the right solution to your needs

J1 Line

2 alarms indicator 96x48mm 1/8 DIN with:
double colour 5 digits display, up to 2 relay alarms and RS485 Modbus/Jbus serial communications

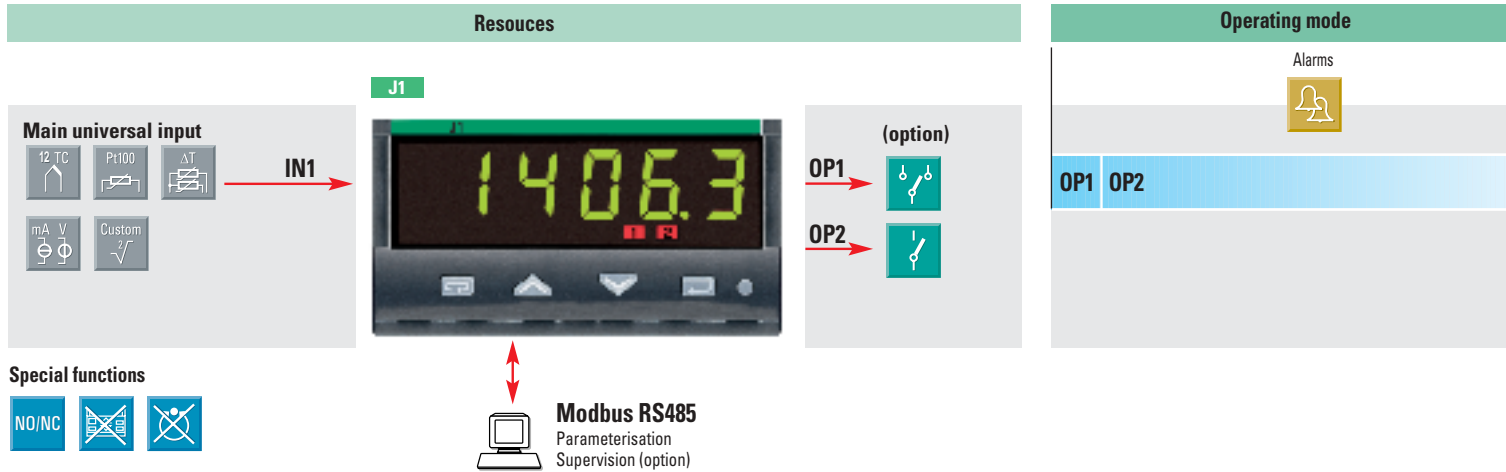

J3 Line

2 inputs indicator 96x48mm 1/8 DIN with:
double colour 5 digits display, 3 digital inputs, IN1 conditioned by IN2, up to 4 relay alarms with ISA A acknowledge sequence, RS485 Modbus/Jbus serial communications and retransmission output

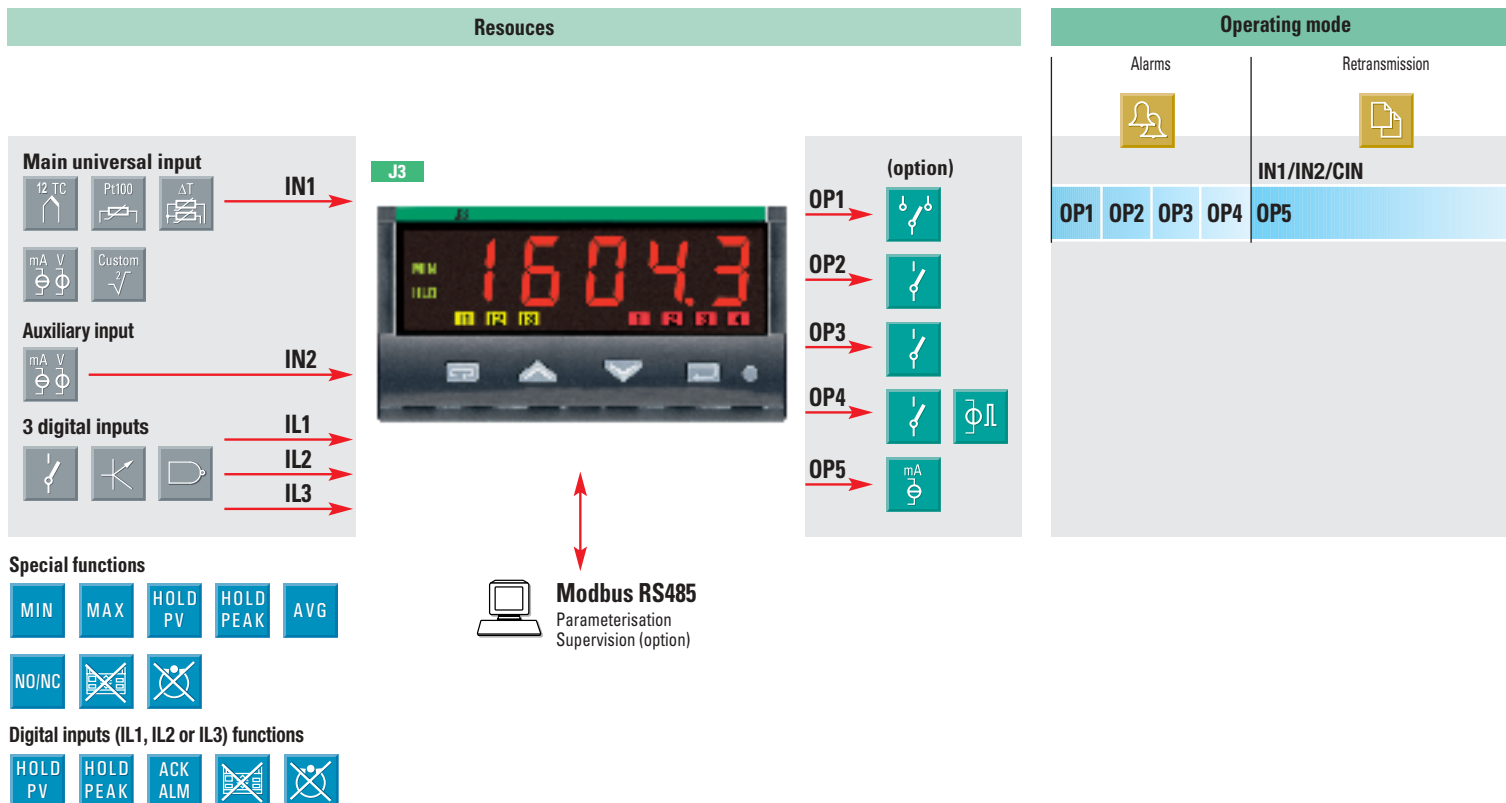

Technical data [note]

Features at 25°C env. temp.	Description		
Total configurability	From keypad or serial communications the user selects: input type, type/functionality and display mode of the alarms		
IN1 input for signal ranges see "Ordering codes"	Common characteristics	A/D converter with 50,000 points Update measurement time: 0.2 s Sampling time: 0.5 s Input shift: -60...+60 digit Input filter: 1...30 s (OFF=0)	
	Accuracy	0.25% ±1 digit (T/C and RTD) 0.1% ±1 digit (mA and mV) Between 100...240 Vac the error is minimal	
	Resistance thermometer (for DT: R1+R2 must be <320Ω)	Pt100Ω at 0°C (IEC 751) °C/°F selectable 2 or 3 wires connection Burnout (with any combination) Line: 20Ω max. (3 wires) Thermal drift 0.35°C/10°C env. T. 0.35°C/10Ω line resist.	
	Thermocouple	L, J, T, K, S, R, B, N, E, W3, W5 (IEC 584) °C/°F selectable Internal cold junction compensation with NTC Error 1°C/20°C ±0.5°C Burnout Line: 150Ω max. Thermal drift <2μV/°C env. T. <5μV/10Ω line resist.	
	DC input current (with 2.5Ω ext. shunt)	0/4...20mA, Rj >10MΩ Engineering units, floating decimal point, configurable Low Range -999...9999 High Range -999...9999 100 digits minimum Input drift: <0.1%/20°C env. T. <5μV/10Ω line resist.	
	DC input voltage	0/10...50mV, Rj >10MΩ	
	IN2 secondary input (opt.)	DC input current: 0/4...20mA, Rj = 30Ω DC input voltage: 0/1...5V, 1...10V, Rj >300kΩ	Accuracy: 0.1% update measurement time: 0.7 s sampling time: 1.5s
Digital inputs 3 logic not isolated logic inputs	Closing an external external contact is possible to	Lock the keypad, lock the output, acknowledge alarms, reset min./max. stored values, hold the measure, Hold/sustain display of positive/negative peaks, force the display of a different variable	
OP1 output (opt.)	SPDT relay, 2A/250Vac (4A/120Vac) for resistive load		
OP2 output (opt.)	SPST relay N.O., 2A/250Vac (4A/120Vac) for resistive load		
OP3 output (opt.)	SPST relay N.O., 2A/250Vac (4A/120Vac) for resistive load		
OP4 output (opt.)	SSR drive not isolated: 0/5Vdc, ± 10%, 30mA max. SPST relay N.O., 2A/250Vac (4A/120Vac) for resistive load		
OP5 (opt.) analogue control output	To retransmit: IN1	Galvanic isolation: 500Vac/1min Resolution: 12 bit In current: 0/4...20mA, 750Ω/15V max.	
	IN2 Conditioned measure	Accuracy: 0.1%	
AL1 - AL2 - AL3 - AL4 alarms	Hysteresis	0.1...10.0%	
	Action	Active high	Action type Changing rate threshold 0.1...5.0 digit/s Deviation threshold ± range Band threshold 0...range Absolute threshold whole range
		Active low	
		Special functions	
Serial comms. (opt.)	RS485 isolated, Modbus/Jbus protocol, 1200, 2400, 4800, 9600 bit/s, 3 wires		
Auxiliary power supply	+24Vdc ±20%, 30 mA max. for external transmitter supply		
Operational safety	Measure input	Detection of out of range, short circuit or sensor break with automatic activation of the safety strategies and alerts on display	
	Parameters	A non volatile memory stores for unlimited time all the configuration and parameter values	
	Access protection	Password to access the configuration and parameters data, keypad lock, outputs lock	
General characteristics	Power supply (PTC protected)	100...240Vac (-15...+10%) 50/60Hz or 24Vac (-25...+15%) 50/60Hz and 24Vdc (-15...+25%)	Power consumption 4W max.
	Safety	Compliance EN61010-1 (IEC 1010-1), installation class 2 (2.5kV), pollution class 2, class II instrument	
	Electromagnetic compatibility	Compliance to the CE standards for industrial system and equipment	
	UL and cUL approval	File E176452	
	Protection EN60529 (IEC529)	IP65 front panel	
Dimensions	1/8 DIN - 96 x 48, depth 110 mm, weight 250g approx.		

Measure conditioning

Primary input IN1 can be conditioned by the secondary input IN2, the result is the conditioned input (C_{in}). The possible conditioning operations are:

Id	Description
In1	Cin = IN1
In2	Cin = IN2
Sum	Cin = IN1 + IN2
Sub	Cin = IN1 - IN2
Avg	Cin = (IN1 + IN2)/2
Hi	Cin = MAX (IN1, IN2)
Lo	Cin = Min (IN1, IN2)
Mul	Cin = IN1 * IN2
Div	Cin = IN1/IN2

Default display variable

When the J3 instrument is set in manual forced display mode (field **M** of order code set at value 5), the user can define the variable that must be displayed as default. Valid values are:

Id	Description
In1	Input 1
In2	Input 2
C _{in}	Conditioned input
Lo	Minimum stored value
Hi	Maximum stored value
Unit	Selected engineering unit

Other functions

- **Keypad lock/unlock** function: to avoid incorrect operator actions
- **Outputs lock/unlock** function: at any moment it is possible set the outputs to OFF, but not the process variable display, without switching-off the power supply.
- **Max./min. display** function: at any time the operator can display the max./min. value stored in the instrument using the keys (max. value). (min value).
- **Peaks and Valleys display** function: the instrument has the capability to display the maximum and the minimum values read, in 2 different modes activated through the digital inputs.

- **Positive/Negative peak hold display**, when the operator activates the digital input, the instrument shows the minimum or the maximum value read. The displayed number changes in case of a reading lower/higher than the stored values.
- **Positive/Negative peak sustained display**, when the operator activates the digital input, all the time the instrument reads a min./max. value, points out it on the display for a programmable period of time (HL dE₁). At the end of the programmed time, the display returns at the normal operation.

Note: The **Features** written in **green** are available only for the J3 model.

"ISA A" Alarm acknowledge sequence

The alarm intervention activates both the visual alarm (the alarm LED on the display) and the audible alarm (the OP output used to activate for example a buzzer or a siren). When the operator acknowledges the alarm, the status of the two alarms differs if the alarm condition has been removed or not. In the table that follows the visual and audible alarm status are pointed out for each condition.

Status	Status changes				Visual alarm (alarm LED)	Audible alarm (OP output)
	Input variable		Reset (ACK)			
	Normal condition	Alarm condition	Reset not done	Reset done		
No alarm active	No status changes	Go to status: Alarm not acknowledged			OFF	OFF
Alarm not acknowledged			No status changes	Go to status: Acknowledged alarm	Flashing	Active
Acknowledged alarm	Go to status: No alarm active	No status changes			Steady ON	OFF

J1 Line ordering codes

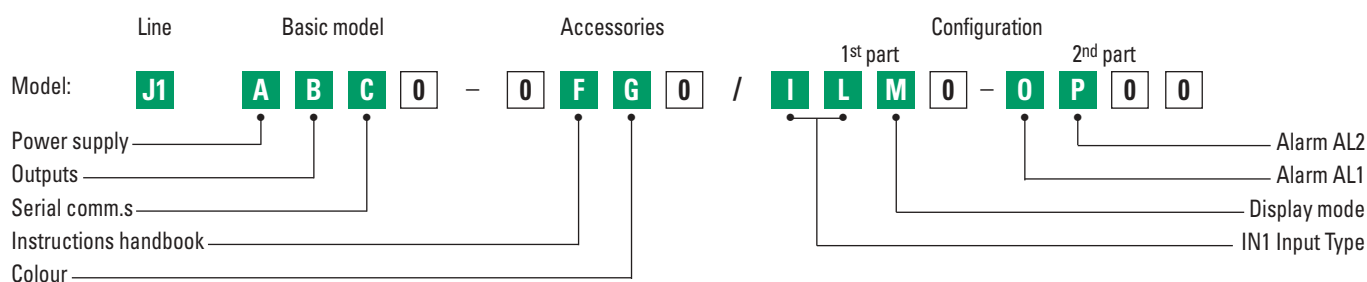

Power supply	A
100...240Vac (-15...+10%)	3
24Vac (-25...+12%) or 24Vdc (-15...+25%)	5
OP1 - OP2 outputs	B
None	0
Relay - Relay	7
Serial communications	C
Not fitted	0
RS 485 Modbus/Jbus SLAVE	5
Instruction handbook	F
Italian-English (std)	0
French-English	1
German-English	2
Spanish-English	3
Front case colour	G
Dark (std)	0
Beige	1

IN1 Input type	Range scale	I	L
RTD Pt100 IEC751	-99.9...300.0 °C -99.9...572.0 °F	0	0
RTD Pt100 IEC751	-200...600 °C -328...1112 °F	0	1
TC L Fe-Const DIN43710	0...600 °C 32...1112 °F	0	2
TC J Fe-Cu45% Ni IEC584	0...600 °C 32...1112 °F	0	3
TC T Cu-CuNi	-200...400 °C -328...752 °F	0	4
TC K Chromel -Alumel IEC584	0...1200 °C 32...2192 °F	0	5
TC S Pt10%Rh-Pt IEC584	0...1600 °C 32...2912 °F	0	6
TC R Pt13%Rh-Pt IEC584	0...1600 °C 32...2912 °F	0	7
TC B Pt30%Rh-Pt Pt6%Rh IEC584	0...1800 °C 32...3272 °F	0	8
TC N Nichrosil-Nisil IEC584	0...1200 °C 32...2192 °F	0	9
TC E Ni10%CR-CuNi IEC584	0...600 °C 32...1112 °F	1	0
TC NI-NiMo 18%	0...1100 °C 32...2012 °F	1	1
TC W3%Re-W25%Re	0...2000 °C 32...3632 °F	1	2
TC W5%Re-W26%Re	0...2000 °C 32...3632 °F	1	3
0...50mV linear	Engineering units	1	4
10...50mV linear	Engineering units	1	5
mV "Custom" scale	On request	1	6

Display mode	M
Green	0
Red	1
Red when alarm 1 (AL1) active	2

AL1 - AL2 - AL3 - AL4 alarm type and function	O	P
Disabled	0	
Sensor break alarm	1	
Absolute		
active high	2	
active low	3	
Deviation		
active high	4	
active low	5	
Band		
active out	6	
active in	7	
Rate alarm (AL1 only)	8	-

If not differently specified the indicator will be supplied with standard version
Model: J1 3000-0000

Electrical wirings

J1 Line

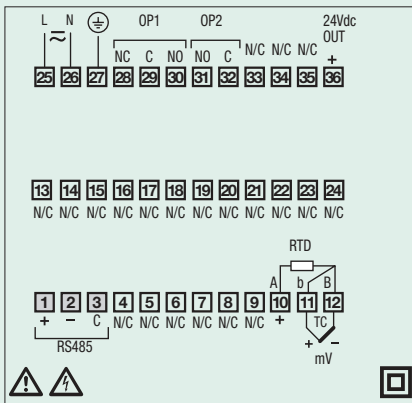

J3 Line

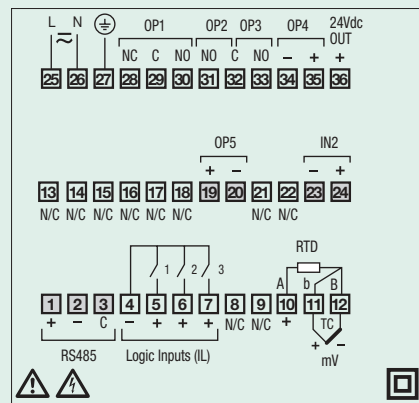

J3 Line ordering codes

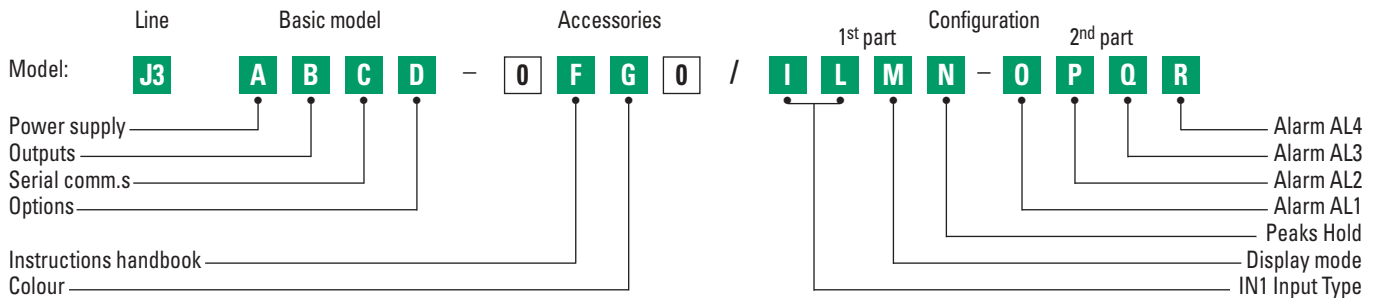

Power supply	A
100...240Vac (-15...+10%)	3
24Vac (-25...+12%) or 24Vdc (-15...+25%)	5
OP1 - OP2 - OP3 - OP4 outputs	B
None	0
Relay - Relay - Relay - SSR Drive	1
Relay - Relay - / - /	7
Relay - Relay - Relay - Relay	9
Serial communications	C
Not fitted	0
RS 485 Modbus/Jbus SLAVE	5
Options	D
None	0
Analogue output for signal retransmission	1
Second port IN2	2
Analogue output for signal retransmission + Second port IN2	5
Instruction handbook	F
Italian-English (std)	0
French-English	1
German-English	2
Spanish-English	3
Front case colour	G
Dark (std)	0
Beige	1

IN1 Input type	Range scale	I	L
RTD Pt100 IEC751	-99.9...300.0 °C	-99.9...572.0 °F	0 0
RTD Pt100 IEC751	-200...600 °C	-328...1112 °F	0 1
TC L Fe-Const DIN43710	0...600 °C	32...1112 °F	0 2
TC J Fe-Cu45% Ni IEC584	0...600 °C	32...1112 °F	0 3
TC T Cu-CuNi	-200...400 °C	-328...752 °F	0 4
TC K Chromel -Alumel IEC584	0...1200 °C	32...2192 °F	0 5
TC S Pt10%Rh-Pt IEC584	0...1600 °C	32...2912 °F	0 6
TC R Pt13%Rh-Pt IEC584	0...1600 °C	32...2912 °F	0 7
TC B Pt30%Rh-Pt Pt6%Rh IEC584	0...1800 °C	32...3272 °F	0 8
TC N Nichrosil-Nisil IEC584	0...1200 °C	32...2192 °F	0 9
TC E Ni10%CR-CuNi IEC584	0...600 °C	32...1112 °F	1 0
TC Ni-NiMo 18%	0...1100 °C	32...2012 °F	1 1
TC W3%Re-W25%Re	0...2000 °C	32...3632 °F	1 2
TC W5%Re-W26%Re	0...2000 °C	32...3632 °F	1 3
0...50mV linear	Engineering units		1 4
10...50mV linear	Engineering units		1 5
mV "Custom" scale	On request		1 6

Display mode	M
Green	0
Red	1
Red when alarm 1 (AL1) active	2
Red when at least one alarm is active (OR function)	3
Alternate between IN1, IN2 and CIN value	4
Manual forced display of IN1, IN2, CIN, Lo or Hi value	5

Hold of the peak values	N
Disabled	0
Shows the max. value (HI peak) for a programmable period of time	1
Shows the min. value (LO peak) for a programmable period of time	2

AL1 - AL2 - AL3 - AL4 alarm type and function	O	P	Q	R
Disabled	1	2	3	4
Sensor break alarm				0
Absolute				1
active high				2
active low				3
Deviation				4
active high				5
active low				6
Band				7
active out				8
active in				-
Rate alarm (AL1 only)	8			-

If not differently specified the indicator will be supplied with standard version
Model: J3 3000-0000



S E R I E S

ASCON spa

Via Falzarego, 9/11
20021 Bollate
(Milano) Italy
Tel. +39 02 333 371
Fax +39 02 350 4243
<http://www.ascon.it>
sales@ascon.it

ASCON FRANCE

2 bis, Rue Paul Henri Spaak
ST. THIBAUT DES VIGNES
F-77462 LAGNY SUR MARNE -
Cedex
Tél. +33 (0) 1 64 30 62 62
Fax +33 (0) 1 64 30 84 98
ascon.france@wanadoo.fr

AGENCE EST

Tél. +33 (3) 89 76 99 89
Fax +33 (3) 89 76 87 03

AGENCE SUD-EST

Tél. +33 (0) 4 74 27 82 81
Fax +33 (0) 4 74 27 81 71

ASCON CORPORATION

472, Ridgelawn Trail
Batavia, Illinois 60510
Tél. +1 630 482 2950
Fax +1 630 482 295
www.asconcorp.com
info@asconcorp.com

WORLDWIDE NETWORK OF DIRECT SALES CENTRES, DISTRIBUTORS AND VARs

Europe

Belgium, Croatia, Czech Rep., Denmark,
Estonia, Finland, France, Germany,
Great Britain, Greece, Holland, Ireland,
Norway, Poland, Portugal, Romania,
Russia, Slovakia, Slovenia, Spain,
Sweden, Switzerland, Turkey, Ukraine

Americas

Argentina, Brazil, Canada, Chile,
Colombia, Ecuador, Paraguay, Peru,
United States, Uruguay, Venezuela

Over the world

Algeria, Australia, China, Egypt, Hong
Kong, India, Indonesia, Iran, Israel,
Malaysia, Marocco, New Zeland,
Pakistan, Saudi Arabia, Singapore,
Taiwan, Thailand, Tunisia, South Africa &
South East Africa, UAE

